

# High-quality automotive electronics for RVs, vans & caravans

- ✓ State-of-the-art technology and accessory products
- ✓ Excellent craftsmanship guarantees reliability and durability
- ✓ Fair and attractive cost-effectiveness ratio
- ✓ Time-tested through years of testing by experienced users
- ✓ 3-year warranty on all Carbest products



## Reliability since more than 18 years

Since 2000 Carbest has stood for high-quality technology products for motor caravans and camping vans. What started out with converters and driver's cab accessories has now become a global market with an extensive product spectrum.

Caravan charging units, LED lights, lithium batteries and camping satellite systems from Carbest are used today as original equipment by many manufacturers.

To offer the Carbest spectrum with an especially attractive cost-effectiveness ratio, our products are purchased directly from specialised factories with no retailers in between. That allows us to offer products at fantastic prices with no compromise in quality.

Products from Carbest are specially developed for use in high-quality RVs, camping vans and caravans. For example, Carbest 12 V chargers are equipped with temperature-controlled fans, because nobody wants to sleep with a loud fan running nearby. In the case of chargers for passenger vehicles or for use in repair shops on the other hand, loudness is not such an important issue. This feature can be eliminated in such applications, but not in camping products.

Extensive tests conducted in the development department in Germany by engineers, technicians and experienced campers ensure that the quality and features of Carbest products are suitable for mobile use in motor vehicles.

More than 38 years of experience in the development and manufacture of camping vans by the Reimo team go into the development of the products. Our priority is to offer products with quality and features that not only make camping fun, but also fulfil the high standards placed on the components used in the manufacture of motor caravans.

Carbest 12 V camping TV sets, for example, are equipped with special mainboards that are reinforced to provide protection against shocks and vibrations.

Conventional household TVs that simply include a 12 V plug would be much less expensive to manufacture, but would not last as long as real camping TVs.

The Carbest sine-wave converter was specially developed for operating air conditioners and capsule coffee makers in caravans.

And because we know that not only the product but also its installation process is important, Carbest converters include the cable for connection to the 12 V batteries, and it goes without saying that they are designed with professional cable cross sections and a length of 2 m.

### Warranty:

The warranty period is 36 months. Reimo reserves the right to eliminate potential errors. No warranty will be given for damages resulting from incorrect use or improper handling.

Limitations of liability: Reimo is in no case liable for collateral damage, consequential damage or indirect damage, costs, expenses, loss of use or loss of profit. The indicated retail price of the product represents the equivalent amount of Reimo's limitation of liability.

© Copyright by Reimo GmbH Egelsbach:

All information in this catalogue is provided as is, without warranty. All rights reserved; errors and modifications excepted. Illustrations can show extras and designs that are not included in the scope of delivery. Reprinting and use in electronic media, also in excerpts, requires the express approval of Reimo GmbH, Boschring 10, 63329 Egelsbach.

Date: March 2018.

# Contents

Flexible solar modules	4 + 6
Flexible solar module complete sets	5 + 6
Rigid solar module complete sets	7 + 9
Rigid solar modules	8
Folding solar panels, powerbanks + solar accessories	10 + 11
Widescreen LED TVs	12 + 13
Satellite systems	14 – 20
TV wall mounts	21
Compressor + absorber coolers	22 – 25
Compressor built-in refrigerators	26
230 V heaters + portable gas continuous-flow heaters	27
Lithium-power batteries + AGM batteries	28
Cara-Move manoeuvring systems	29
Inverters	30 + 31
Charging technology	32 + 33
CEE cables, cable drums, plugs + adapters	34 + 35
12 V SMD LED + COB LED technology	36
Schuko 230 volt accessories	37
COB LED camping + work lights	38
LED flex strips	39
Aluminium profiles for LED flex strips	40
12 V LED area + reading lights	41
Reversing systems	42 – 45
Water pressure-/submersible pumps + exhaust hood	46
Power generators + tambour door	47
Roof lights + frame vent windows	48 + 49
Multi-function ladders	50
Premium furniture design foil	51
Practical travel accessories	52 + 53
Safes + safe boxes	54
Gas + smoke detectors	55



# Ultra-flexible high-power solar modules from 80 to 160 watts

- **Sunpower cells:** Substantial increase in current yield even if angle to sun is not optimal
- **Only 3 mm thick!** Enables a bend radius of up to 20°
- **About 5x lighter** than conventional modules
- **Walkable when glued full-surface**
- **Compact connection** (size ca. 90x75 mm, height ca. 22 mm) with pre-installed 8 m cable (2 x 2.5 mm<sup>2</sup>)
- **High-quality ETFE surface**
- **Ideal also for maritime use**

These solar modules deliver more power than conventional PV modules of the same size. The high-quality ETFE surface with a honeycomb structure increases the power output considerably in twilight and overcast conditions. The special back contact technology of the solar cells enables a bending radius of up to 20°.

Especially at high temperatures, the output is substantially higher than that of comparable modules. The result is maximum efficiency with no compromise in performance. All Power Panel modules feature 1 pre-installed connection cable with a length of 8 m (no messy cable tangle on the roof). The above-average flexibility also makes Carbest modules ideal for maritime use.

#### Material of outer layer:

**ETFE:** Very hard and thin (ca. 0.025 mm) material with high light transmittance of ca. 95%. Heat-resistant up to ca. 150 °C. Very good weather resistance, also suitable for salt water.

#### Material of base plate:

**TPT:** Material with high flexibility. More flexible than fibreglass.  
**Fibreglass:** Very strong, hard material for optimal protection of the solar cells.



Ideal for vans and RVs. Provides for consistent driving behaviour.

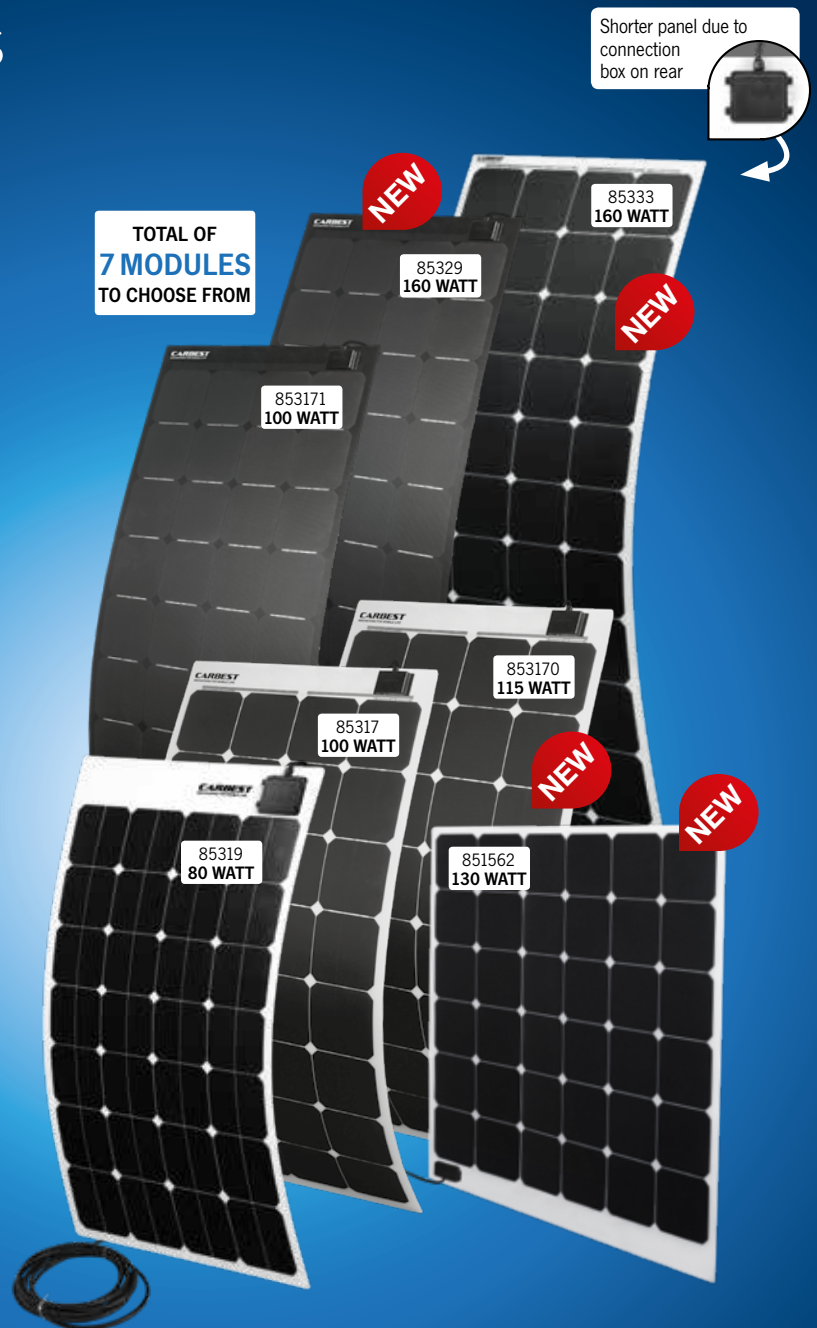

	Power Panel Flex 80 white	Power Panel Flex 100 white	Power Panel Flex 115 white	Power Panel Flex 130 W Square white	Power Panel Flex 100 Pro black	Power Panel Flex 160 Pro black	Power Panel Flex 160 white
Output / number of cells	80 W/56 cells	100 W/32 cells	115 W/32 cells	130 W/36 cells	100 W/32 cells	160 W/44 cells	160 W/44 cells
Material of outer layer	ETFE	ETFE	ETFE	ETFE	ETFE	ETFE	ETFE
Material of base plate	TPT	TPT	TPT	TPT	Fibreglass	Fibreglass	TPT
Efficiency	20.8%	20.8%	23.7%	23.7%	20.8%	23.7%	23.7%
Short-circuit current (Isc)	2.8 A	6.12 A	6.18 A	6.37 A	6.12 A	6.18 A	6.18 A
No-load voltage (Voc)	36.5 V	21 V	23.4 V	25.42 V	21 V	32.2 V	32.2 V
Rated voltage (Vmp)	30.8 V	18 V	19.8 V	21.6 V	18 V	27.3 V	27.3 V
Rated current (Imp)	2.6 A	5.67 A	5.83 A	6.01 A	5.67 A	5.83 A	5.83 A
Dimensions mm LxWxH (Box H)	1000x550x3 (22)	1125x540x3 (22)	1125x540x3 (22)	920x800x3 (22)	1125x540x3 (22)	1505x540x3 (22)	1460x540x3 (22)
Weight incl. 8 m cable	ca. 2.1 kg	ca. 3.1 kg	ca. 3.1 kg	ca. 3.9 kg	ca. 3.2 kg	ca. 5.8 kg	ca. 4.8 kg
<b>Art. no.</b>	<b>85319</b>	<b>85317</b>	<b>853170</b>	<b>851562</b>	<b>853171</b>	<b>85329</b>	<b>85333</b>
<b>Price</b>	<b>280,-</b>	<b>348,-</b>	<b>403,-</b>	<b>453,-</b>	<b>392,-</b>	<b>653,-</b>	<b>566,-</b>

# Solar complete sets with ultra-flexible high-performance solar modules from 80 to 160 watts

- All sets include solar module with pre-installed 8 m cable, high-quality NDS MPPT solar regulator or Votronic MPPT solar regulator and roof bushing

## Complete set Power Panel Flex 80, white

Ideal for silent consumers and for low energy requirements, such as charging mobile phones and other USB devices such as battery packs or cameras, lights and water pump, battery conservation and compensation of silent consumers.

## Complete set Power Panel Flex 100/115 white or black

Set includes the Carbest 100 W/115 W solar module. For light, water pump, occasional heating, for example.

## Complete set Power Panel Flex 160 white or black

Set includes the Carbest 160 W solar module. e.g. for lights, pump, TV/Sat, heating and compressor refrigerator.

## All sets include NDS SC300M MPPT charge regulator

12 V/300 W for gel, AGM, acid or LiFePO4 batteries. 2 separate battery circuits. 2 panels can be connected, standby consumption: 5 mA, dimensions: L 123xW 108xH 50 mm.

TOTAL OF  
**7 SETS**  
TO CHOOSE FROM

## Construction of Carbest ultra-flexible solar modules

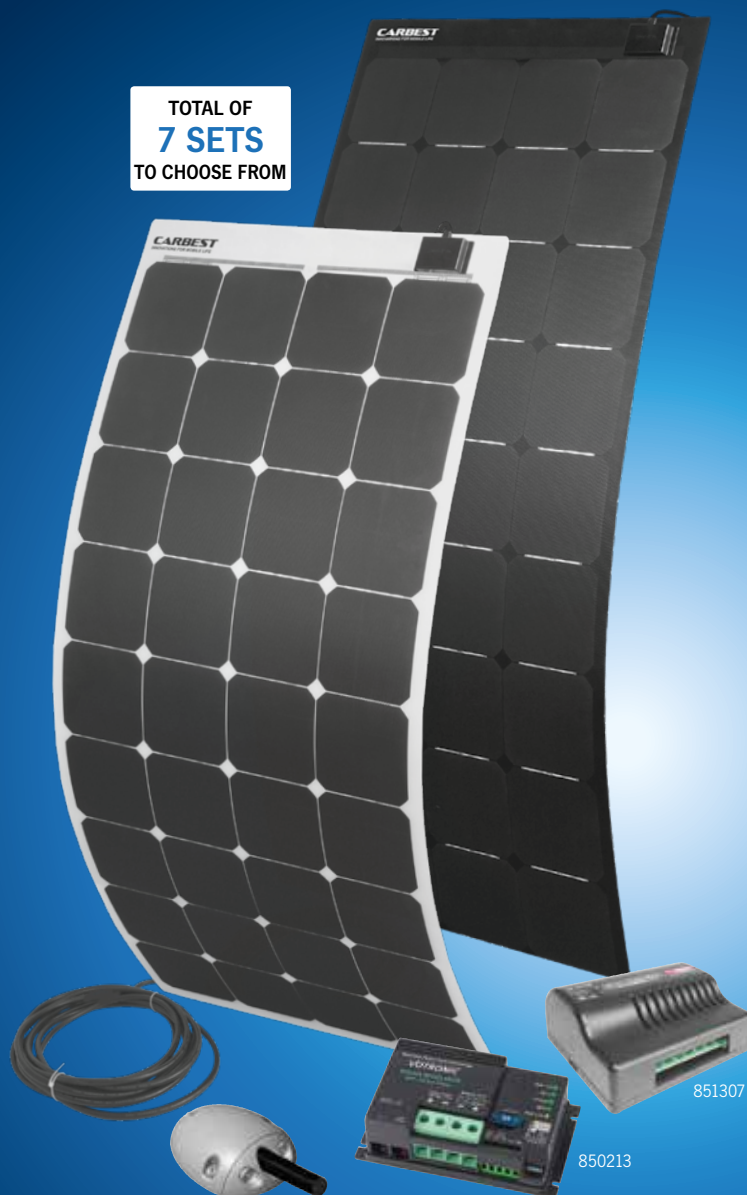
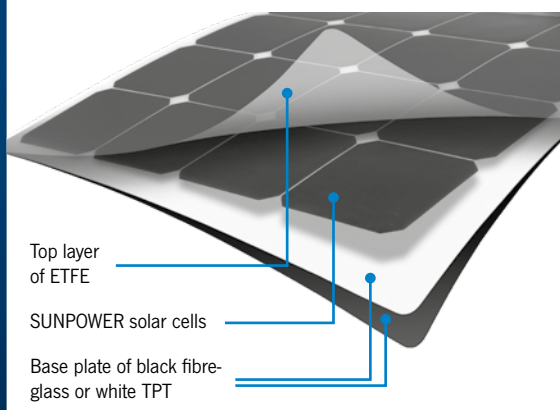

851307

850213

	<b>NEW</b>	<b>NEW</b>	<b>NEW</b>	<b>NEW</b>	<b>NEW</b>	<b>NEW</b>	<b>NEW</b>
	Complete set Power Panel Flex 80 white	Complete set Power Panel Flex 100 white	Complete set Power Panel Flex 115 white	Complete set Power Panel Flex 130 W Square white	Complete set Power Panel Flex 100 Pro black	Complete set Power Panel Flex 160 Pro black	Complete set Power Panel Flex 160 white (connection box on rear)
Solar module power	80 W	100 W	115 W	130 W	100 W	160 W	160 W
Solar module	1x 85319	1x 85317	1x 853170	1x 851562	1x 853171	1x 85329	1x 85333
Charge regulator	850213	851307	851307	851307	851307	850213	850213
Regulator power	165 W	300 W	300 W	300 W	300 W	165 W	165 W
Cable (2x2.5 mm <sup>2</sup> )	8 m pre-installed	8 m pre-installed	8 m pre-installed	8 m pre-installed	8 m pre-installed	8 m pre-installed	8 m pre-installed
Cable bushing	85201	85201	85201	85201	85201	85201	85201
Art. no.	<b>85280</b>	<b>85281</b>	<b>85287</b>	<b>85286</b>	<b>85282</b>	<b>85288</b>	<b>85289</b>
Price	<b>381,-</b>	<b>457,-</b>	<b>490,-</b>	<b>566,-</b>	<b>534,-</b>	<b>784,-</b>	<b>686,-</b>

# Flexible Eco solar modules from 80 to 150 watts

- High-quality monocrystalline solar cells
- 3.5 mm thin
- About 4 x lighter than conventional modules
- Slim connection with 0.9 m cable (2 cables, each 4.0 mm<sup>2</sup>)
- Waterproof fibreglass base plate
- High-quality TPT surface
- Exquisite deep black high-gloss finish

# Complete sets with Eco solar modules

- Sets include solar module, charge regulator and roof bushing
- Slim connection with 0.9 m cable (2 cables, each 4.0 mm<sup>2</sup>)
- Power output from 80 to 150 watts

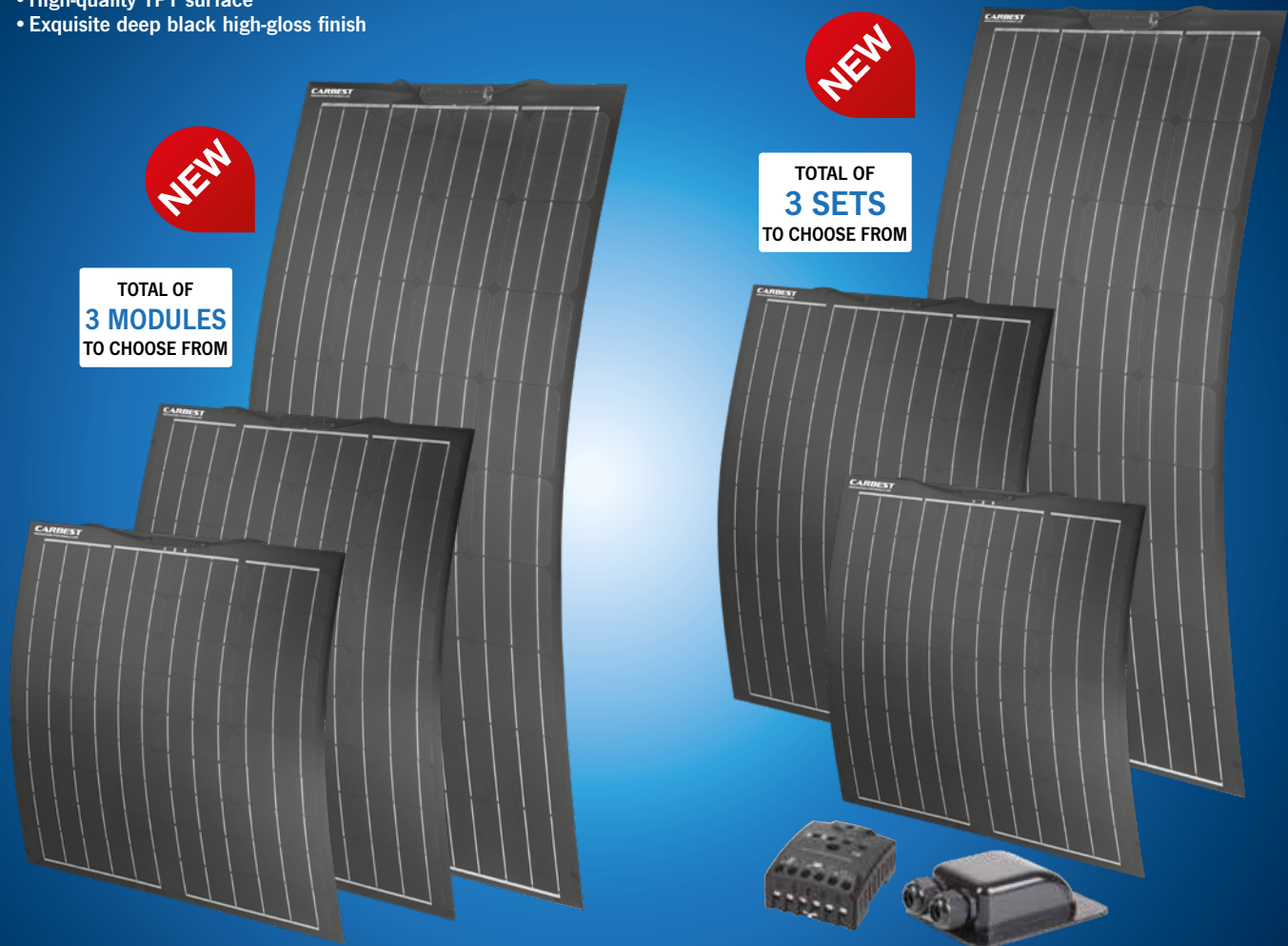

	Power Panel Flex 80 Eco	Power Panel Flex 100 Eco	Power Panel Flex 150 Eco
Output / number of cells	80 W/36 cells	100 W/36 cells	150 W/36 cells
Material of outer layer	TPT	TPT	TPT
Material of base plate	Fibreglass	Fibreglass	Fibreglass
Efficiency	18.30 %	18.43 %	17.87 %
Short-circuit current (Isc)	4.85 A	6.07 A	9.4 A
No-load voltage (Voc)	21.3 V	21.3 V	21.2 V
Rated voltage (Vmp)	17.8 V	17.8 V	17.7 V
Rated current (Imp)	4.49 A	5.62 A	8.71 A
Dimensions mm LxWxH (Box H)	800x670x3.5 (17)	970x670x3.5 (17)	1500x670x3.5 (17)
Weight incl. 8 m cable	ca. 3.0 kg	ca. 3.7 kg	ca. 5.5 kg
<b>Art. no.</b>	<b>85344</b>	<b>85345</b>	<b>85346</b>
<b>Price</b>	<b>207,-</b>	<b>250,-</b>	<b>370,-</b>

	Complete set Power Panel Flex 80 Eco	Complete set Power Panel Flex 100 Eco	Complete set Power Panel Flex 150 Eco
Solar module power	80 W	100 W	150 W
Solar module	1x 85344	1x 85345	1x 85346
Charge regulator	85135	85135	85135
Regulator power	180 W	180 W	180 W
Cable bushing	850494	850494	850494
<b>Art. no.</b>	<b>851067</b>	<b>851068</b>	<b>851069</b>
<b>Price</b>	<b>305,-</b>	<b>337,-</b>	<b>468,-</b>

# Complete solar sets from 80 to 240 watts

- Sets include solar module (s) with aluminium mount, roof bushing, top charge regulator with charge signal for Schaudt EBL in Shunt technology (all sets except starter set), 10 m high-quality solar cable
- Sturdy aluminium frame, silver colour
- Monocrystalline cells
- Tempered glass
- Protected connection with 1 m cable (2x4 mm<sup>2</sup>)
- 25-year performance guarantee (80% performance after 25 years)

TOTAL OF  
**8 SETS**  
TO CHOOSE FROM

## Complete set CB-80

Upgradable starter set. The 243 W charge regulator is sufficient for 2 solar modules, which allows upgrading of the system as needed. Ideal for Hymer & Adria vehicles with a Schaudt panel. The panel measures the charging capacity of the solar module.

## Starter complete set CB-100B

Incredibly priced set with the Carbest 100 W solar module. Regulator power designed for 180 W, therefore expandable.

## Complete set CB-100

Consists of the Carbest 100 W solar module and high-power 243 W solar regulator.

## Complete set CB-100 Slim

Consists of the narrow Carbest 100 W slim solar module (only 410 mm wide) and high-power 243 W solar regulator.

## Complete set CB-120

Consisting of the Carbest 120 W solar module. 243 W regulator power, easily upgradable.

## Complete set CB-140

Consisting of the Carbest 140 W solar module. 243 W regulator power.

## Complete set CB-200

Consists of 2 Carbest 100 W solar modules with a combined output of 200 W and 243 W regulator power for increased energy needs.

## Complete set CB-240

Consists of 2 Carbest 120 W solar modules with a combined output of 240 W and 243 W regulator for even higher energy needs.

ALL SETS INCL. MOUNT, CHARGE REGULATOR, ROOF BUSHING AND 10 m CABLE



PRICE  
HIT

NEW

NEW

	Complete set CB-80	Starter complete set CB-100B	Complete set CB-100	Complete set CB-100 Slim	Complete set CB-120	Complete set CB-140	Complete set CB-200	Complete set CB-240
Solar module power	1x80 W	1x100 W	1x100 W	1x100 W	1x120 W	1x140 W	2x100 W	2x120 W
Solar module	1x850201	1x85226	1x85226	1x85285	1x85227	1x85250	2x85226	2x85227
Charge regulator	85138	85135	85138	85138	85138	85138	85138	85138
Regulator power	243 W	180 W	243 W	243 W	243 W	243 W	243 W	243 W
Cable (2x2.5 mm <sup>2</sup> )	10 m	10 m	10 m	10 m	10 m	10 m	10 m	10 m
Cable bushing	85049	85049	85049	85049	85049	85049	850491	850491
Mounting spoiler	850906	850906	850906	850900	850906	850906	2x 850906	2x 850906
Art. no.	85103	851061	851060	851063	840301	851064	851070	840302
Price	305,-	305,-	359,-	359,-	425,-	479,-	719,-	839,-

All articles on this page expected to be available starting March 2018

# High-performance solar modules from 80 to 140 watts with aluminium frame

- Sturdy aluminium frame:  
(CB series: Silver colour)  
(All-Black series: Black coated)
- Monocrystalline cells
- Tempered glass
- Protected connection  
with 1 m cable (2 x 2.5 mm<sup>2</sup>)
- Power: 80 to 140 watts
- 25-year performance guarantee  
(80% performance after 25 years)

TOTAL OF  
**8 MODULES**  
TO CHOOSE FROM

**NEW**

**CB-100 Slim  
with compact  
design**



**NEW**

**NEW**

**NEW**

**NEW**

	CB-80	CB-100	CB-100 Slim (compact design)	100W All-Black	CB-120	120W All-Black	CB-140	140W All-Black
Output / number of cells	80 W/36	100 W/36	100 W/36	100 W/36	120 W/36	120 W/36	140 W/36	140 W/36
Efficiency	17.0%	20.0%	19.6%	20.4%	20.0%	20.4%	19.6%	20%
Short-circuit current (Isc)	4.98 A	5.83 A	5.66 A	5.85 A	6.87 A	6.89 A	7.89 A	7.89 A
No-load voltage (Voc)	21.88 V	22.82 V	22.74 V	22.8 V	23.49 V	23.47 V	22.99 V	22.96 V
Rated voltage (Vmp)	17.6 V	18.35 V	18.94 V	18.32 V	18.9 V	18.87 V	18.92 V	18.9 V
Rated current (Imp)	4.54 A	5.45 A	5.28 A	5.46 A	6.35 A	6.36 A	7.4 A	7.41 A
Dimensions mm LxWxH	1200x550x35	1200x550x35	1580x410x35	1200x545x35	1450x550x35	1450x545x35	1730x545x35	1730x545x35
Weight	8.3 kg	ca. 7.5 kg	ca. 7.5 kg	ca. 7.5 kg	ca. 9.0 kg	ca. 9.0 kg	ca. 10.5 kg	ca. 10.5 kg
Art. no.	<b>850201</b>	<b>85226</b>	<b>85285</b>	<b>85229</b>	<b>85227</b>	<b>85239</b>	<b>85250</b>	<b>85240</b>
Price	<b>207,-</b>	<b>261,-</b>	<b>261,-</b>	<b>294,-</b>	<b>305,-</b>	<b>359,-</b>	<b>359,-</b>	<b>414,-</b>



# All-Black complete solar sets from 100 to 140 watts

- Sets include solar module with mount, roof bushing, top charge regulator with charge signal for Schaudt EBL in shunt technology, 10 m high-quality solar cable
- With high-quality solar regulator "Made in Germany"
- Monocrystalline cells, black coated aluminium frame
- With pre-installed 1 m connection cable (2x2.5 mm<sup>2</sup>)
- Power: 100 to 140 watts
- 25-year performance guarantee (80% performance after 25 years)

TOTAL OF  
**3 SETS**  
TO CHOOSE FROM

## Complete set 100 W All-Black

Consists of the Carbest 100 W All-Black solar module and high-performance 243 W solar regulator.

## Complete set 120 W All-Black

Consisting of the Carbest 120 W All-Black solar module. 243 W regulator power, easily upgradable.

## Complete set 140 W All-Black

Consisting of the powerful Carbest 140 W All-Black solar module. 243 W regulator power.

ALL SETS INCL. MOUNT,  
CHARGE REGULATOR, ROOF  
BUSHING AND 10 m CABLE

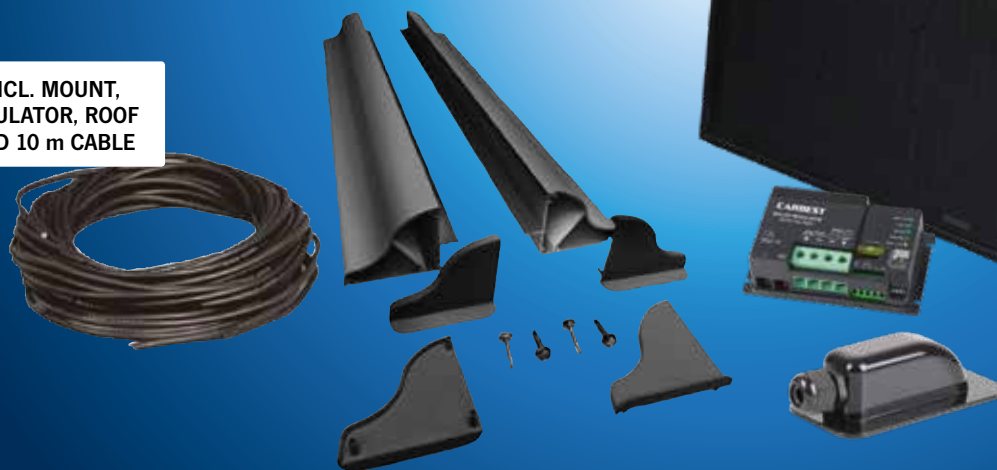

	Complete set 100W All-Black	Complete set 120W All-Black	Complete set 140W All-Black
Solar module power	1x100 W	1x120 W	1x140 W
Solar module	1x85229	1x85239	1x85240
Charge regulator	85138	85138	85138
Regulator power	243 W	243 W	243 W
Cable (2x2.5 mm <sup>2</sup> )	10 m	10 m	10 m
Cable bushing (black)	850493	850493	850493
Mounting spoiler (black)	850909	850909	850909
Art. no.	<b>851062</b>	<b>851065</b>	<b>851066</b>
Price	<b>435,-</b>	<b>523,-</b>	<b>577,-</b>

# High-performance folding solar panels for mobile use



## ① Folding solar panel with 105 watts or 120 watts and charge regulator

- 36 high-performance Sunpower cells
- Built-in charge regulator with additional USB output
- 4 m connecting cable with 3 adapters for different connection options
- Folds into pouch

With USB charge output 5 V/1.2 A in charge regulator. Includes 3 connection adapters with alligator clips, plug for cigarette lighter socket and 12 V power supply plug (e.g. for EFOY GO). Adapter cables can be stored in the patch pocket.

Dimensions opened: 1462 x 560 x 4 mm.

Dimensions folded: 440 x 560 x 20 mm. Weight: ca. 2.3 kg.

105 W panel, rated voltage 19 V/rated current 5.67 A	<b>82505</b>	<b>512,-</b>
120 W panel, rated voltage 20.88 V/rated current 5.97 A	<b>82506</b>	<b>599,-</b>

## Folding solar panels with 9 or 12 solar cells

Lightweight and compact for mobile use anywhere. With eyelets on the corners for fast mounting. Integrated pouch.

② **9 solar cells:** 50 W power. Dimensions: 960 x 680 x 8 mm.  
Folded: 220 x 320 x 60 mm. Weight: ca. 2.5 kg. **82501 185,-**

③ **12 solar cells:** 60 W power. Dimensions: 1,280 x 680 x 8 mm.  
Folded: 220 x 320 x 100 mm. Weight: ca. 3.5 kg. **82502 277,-**

**Connection cable** for interlinking up to 3 panels **82504 12,60**

## ④ Handy folding solar panels with 7 or 15 W power

- With practical mounting flaps and Velcro fastener

Solar panel with 7 W. Output 1 x USB 5 V/1.2 A.  
Size opened: 498 x 238 x 9 mm, size closed: 163 x 238 x 24 mm.  
Weight: 395 g. **85230 54,40**

Solar panel with 15 W. Output 2 x USB 5 V/2.5 A.  
Size opened: 777 x 251 x 9 mm, size closed: 197 x 251 x 32 mm.  
Weight: 610 g. **85231 98,-**

## ⑤ 8000 mAh solar powerbank with LED light

With 8000 mAh polymer battery and battery charge indicator. Includes 2.4 W LED lamps with flashing and continuous light. Output via 2 x USB 5 V (1 x 1 A and 1 x 2 A). Charge via mini-USB or integrated solar panel (5 V/200 mA).

Dimensions: 134 x 76 x 22 mm. Weight: 235 g. **800530 27,20**

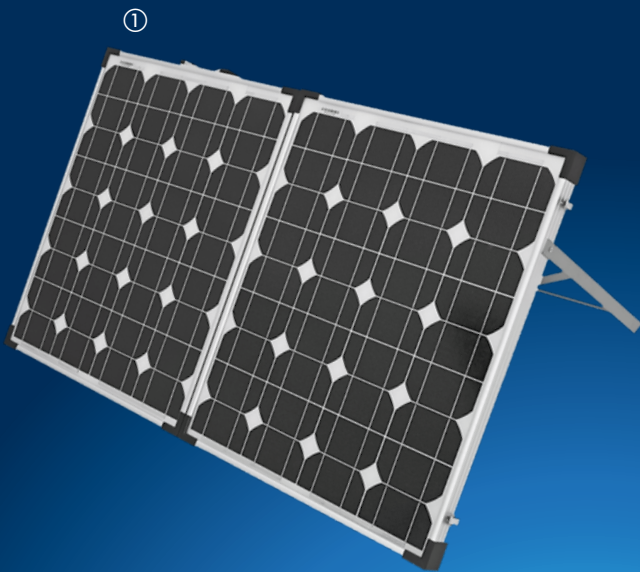

### ① Portable solar panel 60 or 100 watt

- Practical carrying bag included
- Connecting cables with alligator clips (60 W)
- 3 adapter cables for 100 W panel
- Collapsible feet

#### Only with 100 watt portable solar panel:



Rear-mounted charge regulator with USB for charging mobile phones and other devices.

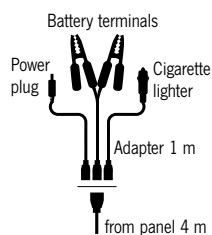

Module power WP	60 W panel	100 W panel
Rated voltage / rated current	21.7 V / 3.33 A	18.0 V / 5.56 A
Efficiency	15%	18.40%
USB connection	5 V / 1.2 A	5 V / 1.2 A
Connection cable	5 m	4 + 1 m
Dimensions open in mm	440x1085x35	1010x650x30
Dimensions closed in mm	440x540x70	505x650x60
Weight	8 kg	11 kg
Art. no.	82503	825031
Price	272,-	414,-

### ② Portable 13 W solar generator with energy box

- Energy box with 7 Ah battery and 2 separate charging cables
- LED work light included

With 12 V and USB port, charging a mobile phone or laptop computer is no problem. Packed size of module: 520x390 mm, opened: 768x520 mm, weight: 4.75 kg, size of energy box: 280x180x100 mm, weight: 3.75 kg. Scope of delivery: Solar module, energy box, LED work light with cigarette lighter connection, charging cable with alligator clips, charging cable for cigarette lighter **850205 130,-**

③ Solar regulator 12 V/24 V – 15 A Optical capacity indicator. Reliable and economically priced charge regulator for solar systems with a charge capacity of up to 360 watts.

**85135 40,30**

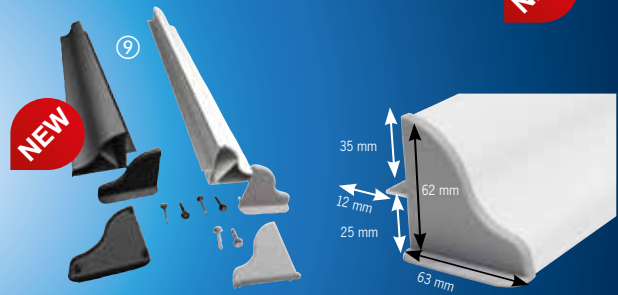

### ④ Effective battery charging also in weak sunlight SR 243 Duo Digital, 12 V

2<sup>nd</sup> output for starter battery, charging program for all battery types (also LiFePo4), LED power indicators, connection for temperature sensor, all regulators can be connected to solar computer. Solar module power min. / max. 30-243 Wp, max. solar module voltage / current: 28 V / 15 A, charging current max. (batt.1/2): 14.7 A / 0.8 A, connection to EBL optional with 851304, dimensions (WxDxH) 131x77x40 mm

Weight ca. 155 g **85138 87,20**

#### Cable bushings

For safe cable routing through roofs or walls. Small, compact, waterproof. For gluing with Sikaflex incl. PG 13.5 screwed cable gland for Ø 6–12 mm cable.

- ⑤ White, 1-way **85049 11,90**
- ⑥ Black, 1-way **850493 11,90**
- ⑦ White, 2-way (L1 2.4xD 9.3xH 3.8 cm) **850491 15,20**
- ⑧ Black, 2-way (L1 2.4xD 9.3xH 3.8 cm) **850494 15,20**

### ⑨ Sturdy aluminium spoiler profile

2-part, can be shorted if necessary, mount for gluing or bolting.

Suitable for Carbest solar modules

Scope of delivery: Extruded profile, plastic caps, assembly instructions

#### Aluminium profile rods 550 mm 2 pieces

(suitable for Carbest modules 850201, 85226, 85227, 85250)

- White **850906 54,40**
- Black **850909 54,40**

#### Aluminium profile rod 410 mm 2 pieces (suitable for Carbest module 85285)

- White **850900 41,50**



## 18.5", 21.5", 23.6" wide-screen LED TVs with DVB-T2/-S2/-C triple tuner

- Wide-angle displays
- 16:9 wide-screen format
- Incl. indoor DVB-T rod antenna
- 12 V operation incl. mains adapter (100 – 240 V)
- Extra On / Off switch on device

12~30 VOLT	100~240 VOLT	DVB-T2 DVB-S2 DVB-C	DVD PLAYER	VIDEO- TEXT
HDMI	USB 2.0	CI+ SLOT	MPEG4	SCART VGA

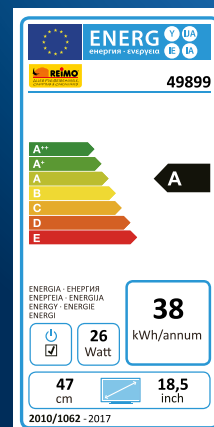
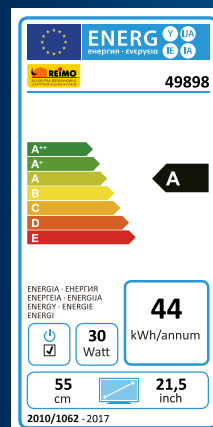
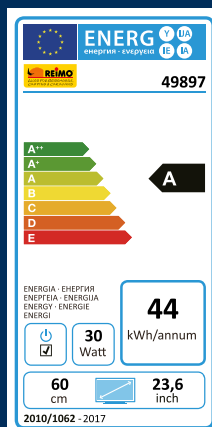



Device type	18.5" HD READY	21.5" FULL HD	23.6" FULL HD
Aspect ratio	16:9 wide-screen format		
Viewing angle	178° H / 178° V		
Operating voltage	12 V DC / 24 V DC / 230 V DC		
TV connections IN	2x RF, 1x Scart, 1x HDMI, 1x VGA, 1x PC-Audio, 1x AV, 1x Ypbpr, 1x CI+ Slot, 1x USB 2.0		
TV connections OUT	1x coaxial, 1x headphone		
Operating / Standby input current	24 W / <0.5 W	36 W / <0.5 W	36 W / <0.5 W
Resolution (pixels)	1366 x 768	1920 x 1080	1920 x 1080
Contrast	1000:1	4000:1	3000:1
Brightness (cd/m2)	200	200	220
Viewing angle	178 H, 178 V		
Dimensions (mm): Without base / with base	WxHxD 435x310x45/180	WxHxD 500x345x45/180	WxHxD 545x375x45/180
EU energy efficiency class	A		
Weight	2.6 kg	3.2 kg	3.7 kg
Scope of delivery	LED TV, power supply 100–240 V, car adapter 12–30 V with cigarette lighter plug, mobile indoor DVB-T rod antenna, mini-AV cable, mini-Ypbpr cable, remote control, user manual		
<b>Art. no. / price</b>	<b>49899 326,-</b>	<b>49898 392,-</b>	<b>49897 414,-</b>

We reserve the right to make technical improvements or modifications, and also to deliver a product of comparable quality from a different manufacturer or supplier. The pictures are similar to the delivered products. Dimensional specifications are approximate.

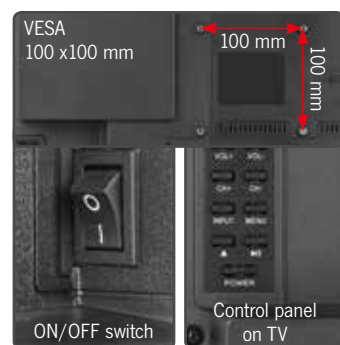

Scope of delivery



**All models with D+ cable!**

**Automatically folds in when the motor starts.**

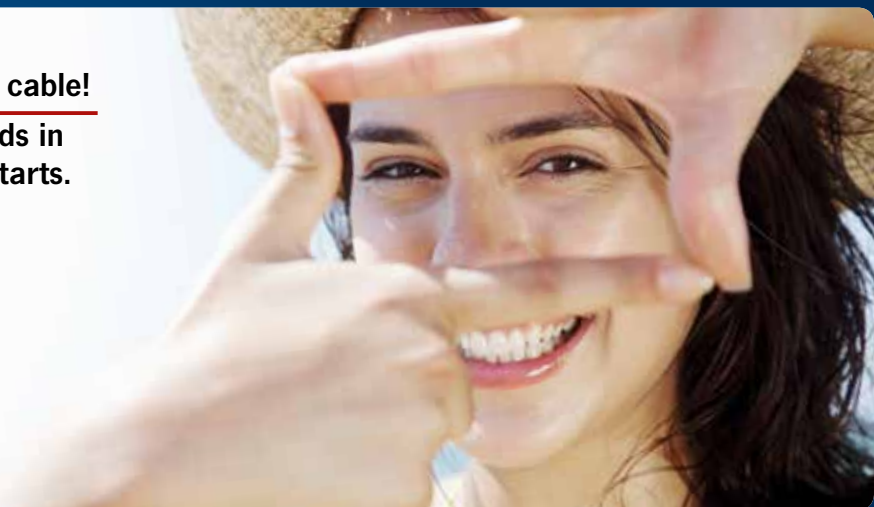

Travelsat systems 68 and 80  
Premium quality  
and reliability at  
a super price

- Extremely robust, maintenance-free metal drive
- Super easy to operate – just push a button to receive the desired satellite
- Fully automatic alignment in about 30–60 seconds

**Technology:** The Travelsat series with state-of-the-art hardware and software technologies.

Easy to update and future-ready: HD and DVB-T2.

**Control unit:** The system is compatible with all decoders (also Sky HD). Reprogrammable software connection without opening the box.

**Positioning:** Fast search of the satellite position. Thanks to GPS the search time is about 30–60 sec, 5–10 seconds when changing satellites. Automatic satellite alignment at the push of a button. 1, 7 or 15 pre-stored satellites. Last detected position is saved.

Acoustic signal warns if antenna is open when vehicles starts up (Plus).

**Details:** Aluminium mounting plate for easy and secure mounting on the vehicle. High-precision gearbox of steel & bronze for a long, maintenance-free service life.

**Technical data:**

12 volt/27 watt (Max. 48 watt during retraction and extension), –15 °C to +50 °C. With CI slot (Common Interface), OSD.

**Dimensions:**

Travelsat 68 / 68 Twin LED: L 618xW 766xH 190 mm, weight: 15.8 kg  
Travelsat 80 / 80 Twin Plus: L 800xW 850xH 190 mm, weight: 16.8 kg

**Scope of delivery:**

Outdoor antenna, control unit without receiver, cable, roof bushing, mounting material, mounting plate and instructions.

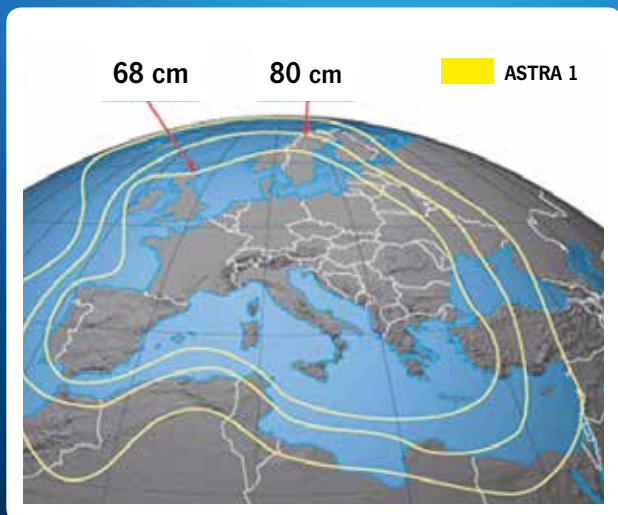



## Travelsat Ø 68 cm

### 1-satellite version ASTRA:

For reception within Europe (yellow zone).

This version can be upgraded with the LED panel to 7 satellites and with the Plus panel to 15 satellites. This gives you versatility also with the less expensive version. Ø max. turning range: 121 cm.

**Travelsat 68 with 1 satellite (ASTRA)\* 49691 1395,-**

Already programmed for ASTRA. No additional control panel needed.

**Travelsat 68 with 1 satellite (HOTBIRD) 49692 1395,-**

### Twin system:

The Comfort version with LED control panel and TWIN-LNB for 2 receivers.

7 satellites pre-programmed. Update via satellite.

**Travelsat 68 Twin with LED panel 49654 1722,-**

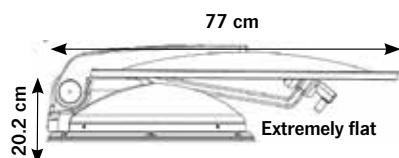

## Travelsat Ø 80 cm

### 1-satellite version ASTRA:

For reception within Europe (yellow zone). This version can be upgraded with the LED panel to 7 satellites and with the Plus panel to 15 satellites. This gives you versatility also with the less expensive version.

Ø max. turning range: 131 cm.

**Travelsat 80 with 1 satellite (ASTRA)\* 49693 1525,-**

Already programmed for ASTRA. No additional control panel needed.

### Twin system:

The Premium version with Plus control panel and TWIN-LNB for 2 receivers.

15 satellites pre-programmed. Update via satellite.

**Travelsat 80 Twin with Plus-Panel 49659 1852,-**

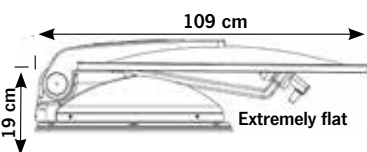

### Optional comfort upgrade functions:

The 1-satellite versions can be upgraded with the LED panel to 7 satellites or with a Plus panel to 15 satellites. This allows you to adapt the Travelsat to your requirements at any time. On request, your Reimo dealer can also change the pre-programmed satellites, for example if the vehicle is sold abroad.



**LED control panel  
7 pre-programmed satellites:**  
Hotbird 13E, Astra 19, Thor, Sirius, Atlantic Bird, Hispasat, Astra 28. (standard for 49654).

**49724 163,-**



**Comfort "Plus" LCD control panel additional functions and 15 pre-programmed satellites:**  
Hotbird 13E, Astra 19E, Astra 28E, Eurobird 16E, Thor 1W, Sirius 5E, Atlantic Bird 5W, Hispasat 30W, Eurobird 9E, Eutelsat 7E, Eutelsat 10E, Amos 3W, Atlantic Bird 8W, Atlantic Bird 12W, Astra 23.5E. (e.g. for Benelux countries) (standard for 49659).

**49725 197,-**



### TWIN system:

The Twin system has a second SAT connection for an additional digital or HD receiver, such as for a TV in the sleeping area or for recording. This allows the independent selection of different programs on the two connections (receiver not included).

### Service:

The widespread SR-Mecatronic service network ensures fast repair or replacement in case of a service call. The Travelsat is then ready for use again in a short time.

# Compact sat antennas with high receiving power

- Compact design with high receiving power
- Small swivel range
- Low height (retracted)
- Easy to operate
- DUO = 2 satellites pre-programmed (ASTRA and Hotbird)



The automatic 60 cm Carbest satellite system is ideal for box vans, caravans or RVs with a small mounting surface. Despite its small size, the compact 60 cm mirror enables very good reception also in Europe's peripheral regions.

The antenna has a connection for one subscriber. The uncluttered, user-friendly control panel offers fully automatic reception at the push of a button. Two pre-programmed satellites (ASTRA and Hotbird) can be selected. Receiver not included.

Carbest 60 DUO white	49740	1198,-
Carbest 60 DUO anthracite	49739	1198,-

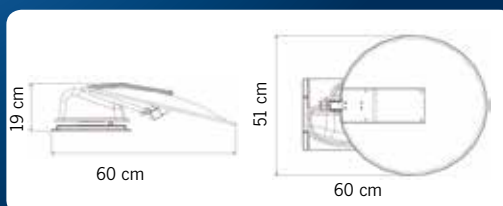



# Snipe Dome dome antenna for TV streaming to mobile devices\*

12 V  
24 V HD

- 8 satellites pre-programmed
- GPS receiver for faster satellite search
- Automatic SAT search at push of button
- TV transmission to mobile end devices such as smart phone or tablet PC (only for Snipe Dome WiFi TV)
- Compact and aerodynamic

(\*TV streaming only possible via Snipe Dome WiFi TV antenna)



## Snipe Dome

Satellite systems with automatic positioner under a plastic dome. Automatic satellite search at push of button within 1–2 minutes when vehicle is parked. The innovative receiver unit enables an extremely compact design that provides optimal protection against external damage. The positioner operates independently and can be used with any satellite receiver. The integrated GPS receiver reduces the satellite search time to only 1–2 minutes.

### Reception ranges:

All German TV and radio programs can be received in Europe's most important vacation countries at the push of a button. The control unit is pre-programmed for a total of 8 satellites.

**Scope of delivery:** Antenna, control unit, 2 x 12 m coax cable, roof bushing, screw set, 12 V car connection cable, screwed cable gland and instructions.

**Dimensions:** LxWxH ca. 660x660x315 mm, weight: ca. 10 kg.

### Technical data:

Temperature range: –30 °C to 60 °C, voltage supply 12–24 volt, signal amplification 33.7dBi @ 12.7GHz, minimum EIRP (footprint) 50dBW. Angle of inclination: 15°–75°, search angle 390°. 8 pre-programmed satellites: Astra 1 (19.2° East), Astra 2 (28.2° East), Astra 3 (23.5° East), Astra 4 (4.8° East), Hotbird (13° East), Thor (0.8° West), Eutelsat 9A (9° East), Hispasat and AB3.

**Snipe Dome** 48298 1122,-



## Snipe Dome WiFi TV for LIVE-TV

See above for details and technical specifications. In addition, TV signals can be transferred directly to smart phones, tablet PCs and notebooks via the built-in WLAN function. Different programs can be viewed on a maximum of 8 mobile devices (up to a maximum distance of 80 m in an open area).

Please note: Interference-free transmission of SAT>IP signals to mobile devices is possible only in the 5 GHz band. Please check whether your mobile devices support the 5 GHz band.

**Dimensions:** LxWxH ca. 660x660x315 mm, weight: ca. 10 kg.  
**Snipe Dome WiFi-TV** 48299 1852,-

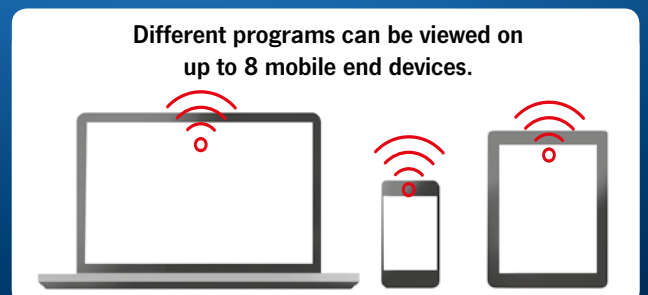



### Snipe Pro

- Active GPS receiver for short search times
- Automatic SKEW function
- Extremely flat, robust aluminium case (only 22.2 cm high)
- 10 satellites pre-programmed, can be selected with external control unit
- Extra reinforcement for high wind loads

### Snipe Pro Max:

- Identical to SNIPE PRO, but with extremely high receiving power (47dBW) and range

#### Comfort features of Snipe PRO and Snipe PRO MAX:

Auto-skew function automatically compensates polarisation shifts due to turning of the antenna. This ensure optimal reception at all European locations. In addition, the integrated active GPS receiver remains in standby via a built-in backup battery, without power from the vehicle. Satellite search time only 1–2 minutes. Large angle for reception (5–90°) in southern and northern Europe. Automatic retraction when vehicle starts up. Auto update of transponder data via satellite keeps Snipe up to date. DVB-S2 also makes it ideal for HD TV. Subject to technical modifications

#### Technical data for SNIPE PRO and SNIPE PRO MAX:

1-subscriber universal LNB. Frequency range: 10.7–12.75 GHz, frequency band: Ku band, polarisation: linear (horizontal/vertical), receiving power: 50 dBW, antenna gain: 33.7 dBi (Snipe Pro) and 36.1 dBi (Snipe Pro Max), angular areas: Azimuth: 360°, elevation: 5°–90°, skew: –60°–+60°. Temperature range: –20 to +60 °C. Voltage range 12 to 24 volts. Power consumption: max. 75 W (searching)

#### 10 satellites pre-programmed:

Astra 1, Astra 2, Astra 3, Astra 4, Hotbird, Thor, Eutelsat 5 West A, Türksat, Hispasat, Eutelsat 9A.

#### Scope of delivery:

Antenna, control unit, mount for control unit, 12 V connecting cable, 12 m coax cable for receiver and control unit, roof bushing, mounting plate and user manual.

#### Dimensions and weights:

Snipe PRO: (LxWxH): 49.1x51.1x22.2 cm, antenna closed: H: 22.2 cm, weight: 13.5 kg  
Space needed for maximum turning range of antenna: ca. 640 mm.  
Snipe PRO MAX: (LxWxH): 51.1x63.8x24.6 cm, antenna closed: H: 24.6 cm. Weight: 16.5 kg  
Space needed for maximum turning range of antenna: ca. 640 mm.

Snipe PRO

48295

1254,-

Snipe PRO MAX

48296

1581,-

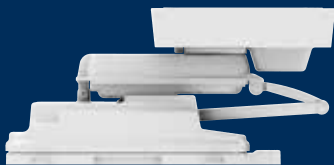

H: 22.2/24.6 cm

**HD**

Can be used  
with any satellite  
receiver.

**12 V**  
**24 V**

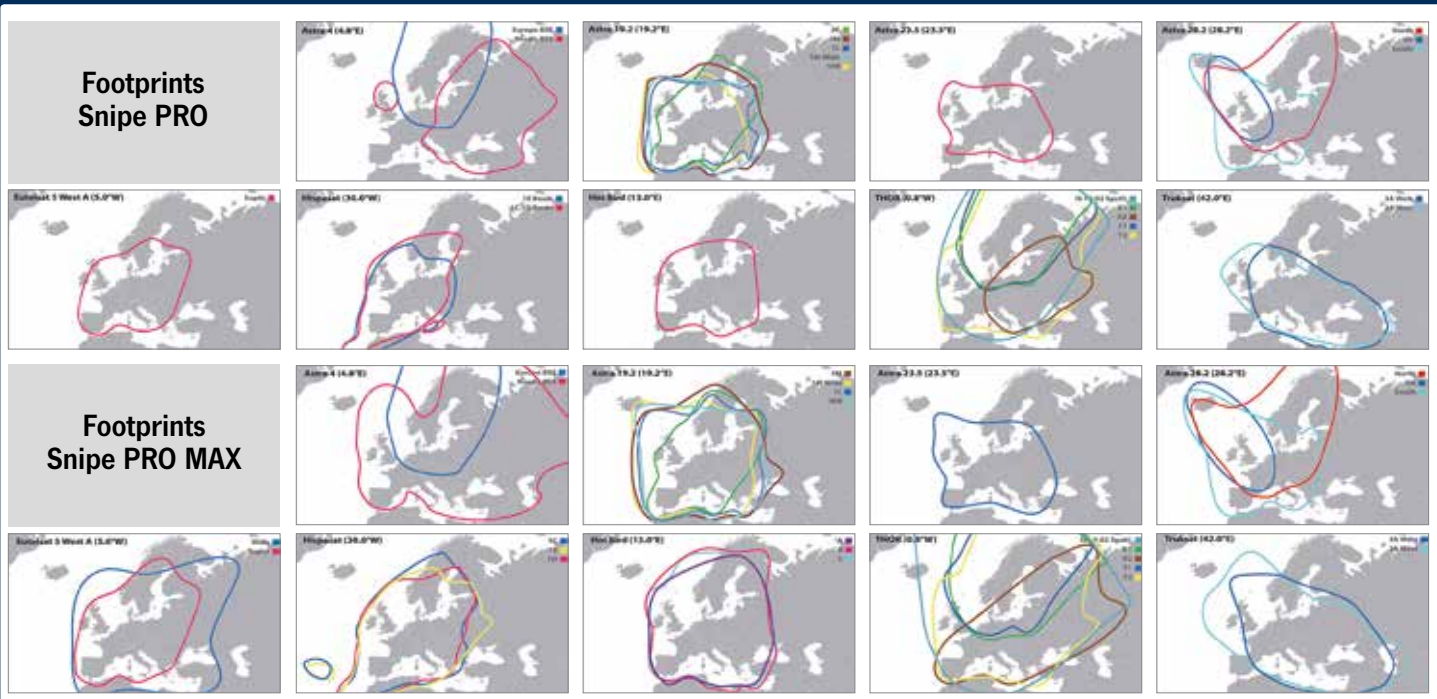

### Snipe 2 + Snipe 3:

- Multi-reception, 10 satellites pre-programmed
- Auto-skew for optimal footprint
- Permanent installation on RV/caravan incl. mounting kit
- Compact dimensions, therefore suitable for numerous vehicles
- Satellite search time max. 120 seconds
- Extremely robust housing provides reliable protection for turning mechanism

HD



Integrated GPS receiver

DiSEqC 1.0/1.1

With reinforced case in front

### Technical data for SNIPE 2 + SNIPE 3:

Input frequency: 10.7..12.75 GHz, output frequency: 950..2.150 MHz.  
 Signal gain: 33.7 dBi/12.7 GHz, polarisation: vertical / horizontal,  
 angular area Snipe 2: 15°..75° / angular area Snipe 3: 15°..90°.  
 Azimuth: 360°, operating temperature: -30 °C .. +60 °C, voltage 12 volt.  
 Consumption: 30 watts during satellite search. Software update via USB on control unit. 10 satellites pre-programmed: (ASTRA 1/2/3/4, HotBird, Türk-sat, Thor, AB3, Eutelsat, Hispasat). Dimensions: ca. 515x355x210 mm.  
 Weight: ca. 10.3 kg.

**Scope of delivery:** Motor unit with electronic control, mounting plate, roof bushing, transport case and cable set. Flat antenna pre-mounted on outer unit. With control unit, 12 V connecting cable and user manual.

- ① Snipe 2, colour Dark Gray 482942 850,-
- ② Snipe 3, colour White 482943 1089,-

Snipe 2 and Snipe 3 footprints (Eutelsat 9A not shown):

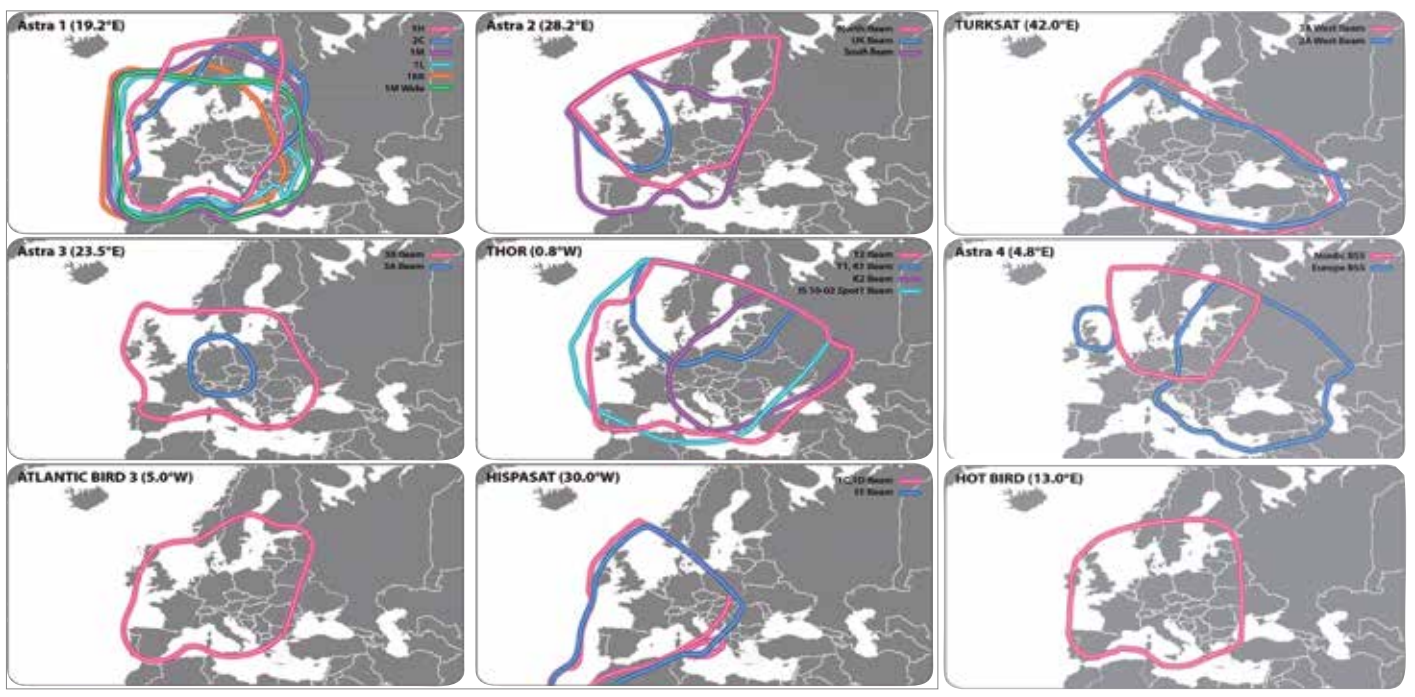
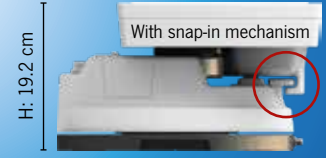

# Compact DVB-T2 antennas for outdoor, car or caravan



DVB-T2

12 V  
24 V

230 V

Fixed installation or mobile mounting

Time-proven in 4 years of use

## Eric – digital DVB-T2 antenna

- For receiving digital terrestrial signals
- With high-quality amplification and switching technology
- Protected against UV radiation and splashing water
- Suction cup for installation on smooth surfaces
- 12/24 volt operation, with cigarette lighter connection
- 230 volt power adapter included
- For TVs with 5 V supply via antenna output
- For TVs without 5 V supply the 5 V supply voltage can be looped in via 12 & 230 V

**Technical data:** DC 12/24 volt, UHF 470~870 MHz, VHF 47~230 MHz, amplification level: 20 +- 3dB low-loss amplification technology. Dimensions: H 200xW 105xD 80 mm (without base). **Scope of delivery:** Antenna, flexible mounting bracket, pole mounting set, 5 V component for supply voltage, coax cable, 12 V and 230 V power adapter, flexible mounting element with Ø 70 mm suction cup, cigarette lighter cable, user manual.

494101

64,30



DVB-T2

12 V  
24 V

Cable routing through aluminium base

## The active DVB-T2 omnidirectional antenna for roof mounting with TOP reception

- Reception of regional digital programs
- Integrated amplifier
- Concealed cable routing (through antenna base)

Antenna with state-of-the-art SMD technology. Excellent reception of digital terrestrial TV (DVB-T) and radio programs (DAB radio). Reception of local / regional FM radio signals. With built-in amplifier. Extremely large frequency range. Weatherproof, no-rust, version with aluminium base.

### Technical data:

Frequency ranges: FM 87.5-108 MHz, VHF 174-230 MHz, UHF 470-862 MHz.

Opening angle: vertical 90° / horizontal 360°, output level: max. 108 dB V, amplification: 35 dB, input voltage: DC 12/24 V, operating voltage: 5 V DC, connection: F-plug. Dimensions: Ø base: 13 cm, Ø antenna: 30 cm, overall height: 20 cm

49410

131,-

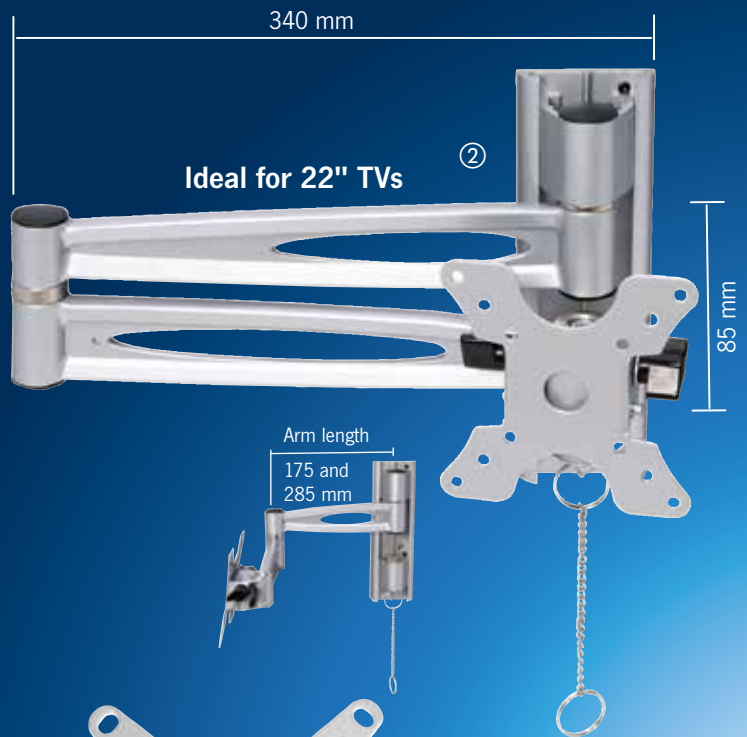
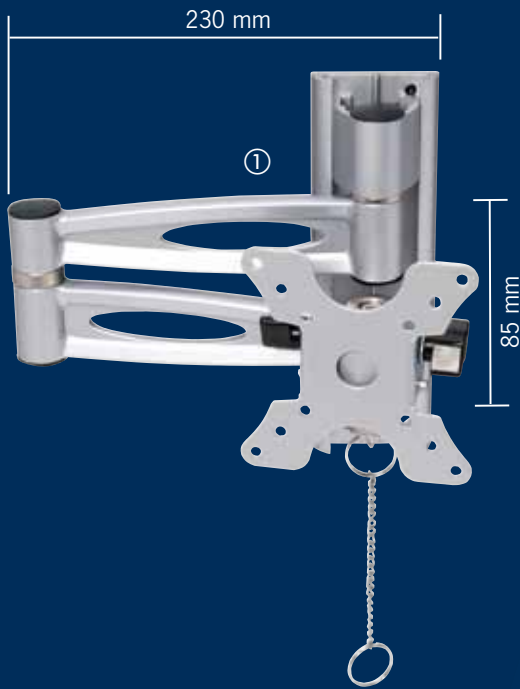

## Strong TV wall mount for Carbest TVs

### TV wall mount with locking screws

- Wall mount TFT mount in 2 versions
- For monitors from 15" to 23"
- Hole pattern 50, 75 and 100 mm (VESA)

① **Carbest TV mount Simon Luxus**  
Locks securely for driving. Arm length 175 mm each.  
Length extended 430 mm. Load capacity up to 10 kg. Weight:  
ca. 1 kg. Aluminium silver. **493960** **76,30**

② **Carbest TV mount Simon Luxus XL**  
Like Simon Luxus TV mount, but with arm length 285 mm each.  
Length extended 650 mm. Load capacity up to 10 kg. Weight:  
ca. 1.4 kg. Aluminium silver. **493970** **84,-**

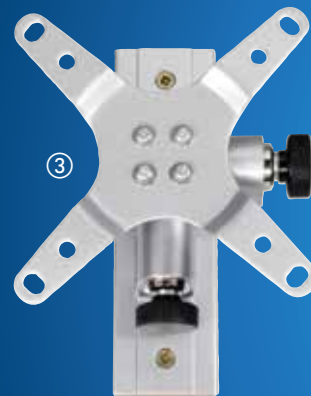

### TV wall mount with locking screws

- Wall mount TV mount in 3 versions
- For monitors from 13" to 30"
- Hole pattern 75 and 100 mm (VESA)

③ **Wall mount TV mount S**  
The quality has been approved with new thumb screws.  
Dimensions: 114x114x98 mm. Load capacity up to 10 kg.  
Weight: 0.6 kg.  
Aluminium silver. **493962** **30,60**

④ **Wall Mount TV mount M**  
Dimensions: 116x152x81 – 235 mm load capacity up to 10 kg.  
Weight: 0.8 kg. Aluminium silver. **493961** **52,30**

⑤ **Wall Mount TV mount XL, aluminium**  
Dimensions: 116x152x81 – 390 mm load capacity up to 10 kg.  
Weight: 1 kg.  
Aluminium silver. **49396** **56,40**

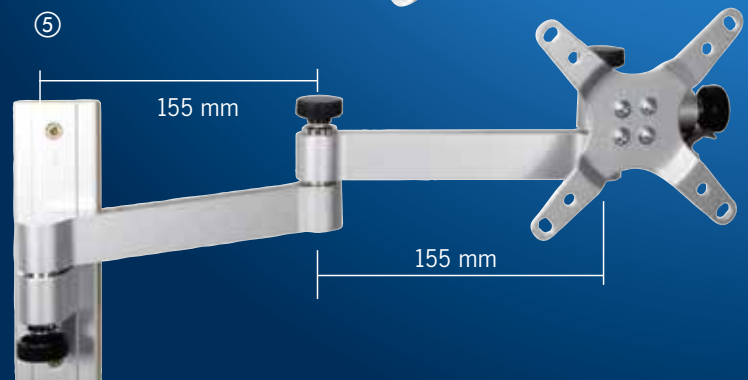

# MaxiFreezer – Robust compressor coolers with 40 l, 50 l or 60 l volume.

**NEW**

Cools from -20 °C to +10 °C.

**12 V** **220 V**  
**24 V** **230 V** **A++**

Lid opens on both sides and is completely removable

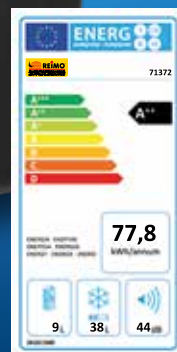
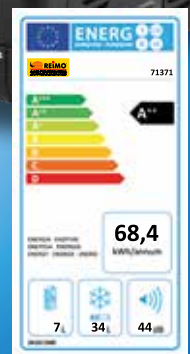

- Extremely robust case with camera protection
- 2 sturdy handles (load capacity up to 140 kg)
- Removable cover, opens on both sides
- Easy to clean due to removable basket insert and floor drain
- Electric thermostat with digital temperature display
- Dependable, quite-running compressor
- Battery monitor protects vehicle battery
- Energy-saving LED interior lighting
- LED display for easy operation
- Scope of delivery: Cooler, connecting cable, user manual
- Thermal protective bag optionally available. Protects the cooler from dirt and scratches. Insulating effects improves the cooling capacity.



Thermal protective bag optionally available



Model	MaxiFreezer 40 litre	MaxiFreezer 50 litre	MaxiFreezer 60 litre
Usable volume (litres)	Refrigerator / freezer compartment: 7/34	Refrigerator / freezer compartment: 9/38	Refrigerator / freezer compartment: 12/45
Supply voltage	12 / 24 V DC, 220 – 240 V AC	12 / 24 V DC, 220 – 240 V AC	12 / 24 V DC, 220 – 240 V AC
Power consumption	12 V / 4.2 A / 50.4 W 24 V / 2.2 A / 52.8 W 220 – 240 V / 0.4 A / 56 W	12 V / 4.2 A / 50.4 W 24 V / 2.2 A / 52.8 W 220 – 240 V / 0.4 A / 56 W	12 V / 4.2 A / 50.4 W 24 V / 2.2 A / 52.8 W 220 – 240 V / 0.4 A / 56 W
Temperature range	+ 10 °C to – 20 °C		
Energy class	A ++		
Colour	Flat black / Flat blue		
Dimensions (L x W x H)	714 x 449 x 446 mm	714 x 453 x 469 mm	714 x 453 x 524 mm
Item no.	<b>71371</b>	<b>71372</b>	<b>71373</b>
Price	<b>762,-</b>	<b>839,-</b>	<b>926,-</b>
Thermal bag	<b>713710</b>	<b>713720</b>	<b>713730</b>
Price	<b>54,40</b>	<b>59,90</b>	<b>65,30</b>
Connection cable for UK	<b>713711</b>		
Price	<b>10,90</b>		

Contents not included

# High-power 38 litre absorber cooler with 12 V, 230 V or gas operation



- Compact cooler with practical recessed handles
- Standing height for 15x 1 litre bottles
- 2 D-rings for fastening tie-down straps
- Continuous flame adjustment in gas operation
- Continuous thermostatic adjustment in 230 V operation
- 12 V fan for better cooling in 12 V operation
- With integrated spirit level for optimal alignment



30 mbar connection 50 mbar connection

Connected loads: 12 volt, 7.5 A, 90 watt, 230 volt / 50 Hz, 0.35 A, 90 watt, gas operation 30 mbar and 50 mbar. Cooling capacity: 5 °C to 10 °C (20 °C to 25 °C below ambient temperature). Dimensions WxDxH: 500x470x440 mm. Weight: ca. 18 kg

<b>30 mbar</b>	<b>713581</b>	<b>294,-</b>
<b>50 mbar</b>	<b>71358</b>	<b>294,-</b>



# Compact compressor coolers



For VW T5/T6



For Fiat Ducato



For passenger compartment



**VAN S**  
9 litre compressor cooler

- Fits between driver's seat and passenger seat in VW T5/T6
- With beverage holder, interior light and ice cube tray
- Carrying strap and 2 anchor points for fastening

Cooling capacity: -18 °C to 10 °C  
 Dimensions WxDxH: ca. 210x459x320 mm  
 Weight: ca. 8.5 kg. Connection: 12, 24 and 230 V, input current ca.35 watt

**71354 435,-**



**VAN M**  
16 litre compressor cooler

- Fits between driver's seat and passenger seat in Fiat Ducato
- With inside light & ice cube tray
- Carrying strap included

Cooling capacity: -18 °C to 10 °C  
 Dimensions WxDxH: ca. 230x532x384 mm  
 Weight: ca. 10 kg. Power consumption: ca. 0.35 kWh - 0.53 kWh.  
 Connection: 12, 24 and 230 V.  
 Power consumption ca.40 watt

**71355 490,-**



**L**  
33 litre compressor cooler

- Ideal for passenger compartments, awnings or rear garages
- Incl. ice cube tray

Cooling capacity: -18 °C to 10 °C  
 Dimensions WxDxH: ca. 379 x540 x455 mm  
 Weight: ca. 12 kg.  
 Connection: 12, 24 and 230 V.  
 Power consumption ca. 40 watt

**71356 741,-**

# Compact built-in compressor refrigerators

with 40 l or 50 l volume and high-quality stainless steel enclosure

40L



Ca. 180 cm long connection between compressor unit and refrigerator. (Only for 40L model)

50L

12 V

NEW



Contents not included



- Easy-to-operate LED display
- High-quality stainless steel enclosure
- Freezer compartment with ice cube maker

## 40 litre built-in refrigerator

With 34 l cooling compartment and 6 l freezer compartment. LED display with controls on front of door. **The 180 cm long connection tube allows offset installation of the compressor unit.**

Cooling capacity: Refrigerator 0 – 10 °C, freezer compartment max. – 12 °C. Connection: 12 / 24 volt, power consumption ca. 45 watt, dimensions: W xHxD 380x510

(+30 mm feet)x508 mm. Weight: ca. 15 kg

71357

828,-

## NEW! 50 litre built-in refrigerator

Features identical to 40 litre built-in refrigerator but with 44 l cooling compartment, 6 l freezer compartment and without offset compressor unit.

Dimensions: W xHxD 390x510 (+30 mm feet) x510 mm.

Weight: ca. 17 kg

713570

861,-

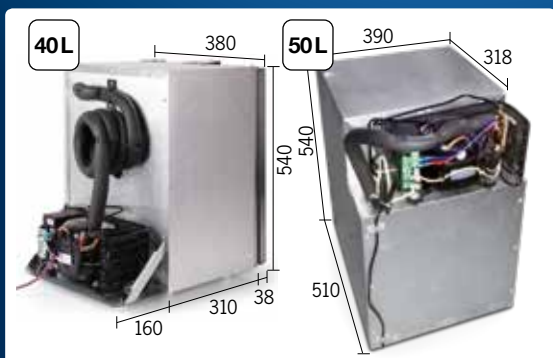

NEW

## Universal 12 V refrigerator fan

With thermostat and wall mount, 3.6 W with 3000 rpm. Dimensions: 92x92x25 mm

81166

21,70

# High-power 230 V heaters

**230 V**



① **Fan heater Pietro** with 2 power stages:  
750 / 1500 W, 12 h timer and LED display. Automatic tip-over protection, temperature regulator and overheating protection.  
Weight: 1.8 kg. Dimensions: W22xH29xD12 cm  
**811527 45,70**

② **Fan heater Niilo**  
1000 / 2000 W, 230 V. 2-stage regulation.  
With overheating protection. Dimensions: H30xW20xD15 cm  
**811524 14,90**

③ **Ceramic heater Ivalo with tip-over protection**  
750 / 1500 W, 230 V, self-turning (oscillating). With overheating protection and automatic tip-over protection – power supply is shut off immediately if it tips over.  
Dimensions: H26xW20xD13 cm  
**811522 32,60**

④ **PTC ceramic heater 230 V**  
• 2 power stages 750 W / 1500 W  
• 2 functions: heat / ventilation  
• Double overheating protection  
• Quiet

2 power stages: 750 watt and 1500 watt. Can be switched between heating or ventilation as desired. Adjustable thermostat for temperature control and setting. Automatic shut-off if the heater tips over, to prevent danger of fire. Power indicator. Safe ceramic heating element. CE tested.  
Approx. size: H22xW21.5xD22.3 cm.  
Approx. weight: 2 kg **811525 37,10**

# Portable gas continuous-flow heater

- Continuous warm water – wherever you go
- Hot water from the tap or shower head
- Continuously adjustable water temperature
- Strong water flow – ca. 2.7 litres per minute
- Automatic ignition
- Integrated safety function
- Robust carry bag included
- Heats water from 30 °C to 55 °C

Water flow temperature continuously adjustable from minimum temperature 30 °C, (5 litres per minute) to maximum temperature 55 °C (2.7 litres per minute).

Technical data: W 250xH 350xD 285 mm, weight 5.5 kg, automatic ignition, overheating protection (55 degrees), automatic shut-off if device tips over.

Scope of delivery: Carrying bag, water hose and pump, 12 volt adapter, shower head.

**These units are not approved for use in closed rooms!**

D, CH, A	50 mBar	67041	326,-
Europe	30 mBar	67042	326,-



Can optionally be used only with spigot.  
(5 litres/min. at 30°)



Water hose with submersible pump



12 volt adapter with ca. 5 m cable



Shower head with water stop button



Robust carrying bag





# Lithium power



## Lithium iron phosphate batteries (LiFePO4) with battery management function

- Super compact, very long life!
- Battery protection due to integrated battery management function
- Reliable and powerful battery technology, designed for continuous use!
- Up to 90% current drain (short-term)
- 3 times less weight – allows additional payload
- 5 – 10 times longer life (ca. 2000 – 5000 cycles)
- 3 – 10 times faster charging
- Battery connection with screw terminals

### Carbest LiFePO4 battery series

Lightweight, compact and safe lithium batteries with integrated battery management function. Ideal for leisure, hobby, RV and caravan. Charge with AGM – or preferably – lithium chargers.

Type	Volt (V)	Ah*	Length mm	Width mm	Height mm	Weight kg	Art. no.	Price
20	12	20	180	75	165	2.7	81207	326,-
60	12	60	195	165	180	7.2	81208	795,-
100	12	100	305	170	210	13	81209	1307,-

\*90% power availability



★★★★★  
PREMIUM PRODUCT

Professional quality

Time-proven for 3 years



## Carbest LiFePO4 Pro battery

- In a long-term test the test unit still achieves a current of more than 105 Ah after 2 years of continuous use!
  - In test up to 10 cups of espresso with Nespresso machine
- For recreational and professional use, in RVs in caravans. Can be charged with normal chargers for AGM or gel batteries, but we recommend a charger with lithium charge voltage or use of a charge booster (800243). Battery monitoring via LED.

Type	Volt (V)	Ah*	Length mm	Width mm	Height mm	Weight kg	Art. no.	Price
110	12	110	260	172	225	15.8	81382	1634,-

\*Almost 100% power availability



## Carbest Deep-Cycle AGM batteries

- Installation in living spaces possible in accordance with EC regulations
- Absolutely maintenance-free and eco-friendly
- Long cycle life, ideal also for solar systems

Carbest AGM batteries were specially developed as service batteries for use in recreational vehicles. The ideal service battery for use in motor caravans and boats. The 100 T5 fits horizontally under the passenger seat of the Volkswagen T 5/6. The excellent life cycle\* and the low self-discharge make it perfect for recreational use.

The compact design fits in standard battery devices and stowage compartments. AGM batteries are frostproof down to -40 °C. They can be installed either horizontally or vertically. (Do not install overhead, with the battery posts pointing downward). Not hazardous material, therefore approved for dispatch!

Type	Volt (V)	Ah* (100 h)	Ah** (20 h)	Length mm	Width mm	Height mm	Weight kg	Art. no.	Price
① 80 PL	12	90	80	350	167	179 °	22.5	850529	240,-
② 100 T5	12	110	100	353	175	190	26.3	850530	273,-
③ 100 PL	12	110	100	330	171	220 °	29.0	850531	273,-

\*C100 (value at 100-hour discharge) \*\*C20 (value at 20-hour discharge)  
° plus height of the battery posts

# Cara-Move – powerful manoeuvring system manual or fully automatic

- Sturdy aluminium drive rollers
- Soft-start precision control
- Compact, sturdy, reliable
- Convenient remote control



## Cara-Move manual version

The manual caravan manoeuvring aid moves single- and double-axle caravans up to a maximum total weight of 2250 kg. Rollers are engaged and disengaged manually. Power consumption on level ground: ca. 25 A. Max. power consumption (1100 kg single-axle caravan, 25% slope): 80 A, weight: 35 kg

Scope of delivery: 2 motors, dash panel, remote control, battery circuit-breaker (100 A), engaging lever, mounting material, user manual  
**920208 980,-**

## Cara-Move fully automatic version

The fully automatic caravan manoeuvring aid moves single- and double-axle caravans up to a maximum total weight of 2250 kg. Rollers are engaged and disengaged in a convenient, fully automatic process. Power consumption on level ground: ca. 25 A. Max. power consumption (1100 kg single-axle caravan, 25% slope): 80 A, weight: 40 kg.

Scope of delivery: 2 motors, motor for engaging and disengaging, dash panel, mounting material, remote control, user manual, battery circuit-breaker (100 A)  
**920202 1250,-**

## Carbest all-inclusive battery bundle

The Carbest all-inclusive battery bundle is the perfect accessory for your manual or fully automatic Carbest Cara-Move manoeuvring system.

The set consists of: 1 charger (10 A), 1 AGM mains lead, 1 AGM battery 80 Ah, 1 battery box, 2 battery terminals. Total weight ca. 25.5 kg.

**9202022 381,-**



# Operate 230 volt devices on 12 volt converters

- For all standard household appliances (e.g. laptop, hair dryer, coffee maker, etc.)
- Switch-mode technology: virtually silent operation
- Connection for remote control
- USB connection
- Undervoltage / overvoltage protection protects battery
- Reverse polarity protection, overload protection
- CE and e-mark\* certified for installation in motor vehicles



Suitable cable remote controls:  
For ④ and ⑤ with 4.5 m cable  
**81949**                      **27,20**

Illustration	①	②	③	④	⑤
<b>Type</b>	<b>MS 200U</b>	<b>MS 400U</b>	<b>MS 600U</b>	<b>MS 1000U</b>	<b>MS 2500U</b>
Input voltage DC	12 V	12 V	12 V	12 V	12 V
Input voltage range		9.5 – 16 V	9.5 – 16 V	9.5 – 16 V	9.5 – 16 V
Continuous power		250 W	500 W		2300 W
Rated power	200 W	400 W	600 W	1000 W	2500 W
Temporary peak power	400 W	600 W	1200 W	2000 W	5000 W
Output voltage (±5%)	230 V	230 V	230 V	230 V	230 V
Shut-off threshold / undervoltage	10.0±0.5 V	10.0±0.5 V	10.0±0.5 V	10.0±0.5 V	10.0±0.5 V
Steady current		<0.85 A	<1.0 A		<1.5 A
Efficiency		>95%	>92%		>90%
Cooling	–	Fan	Fan	Fan	Fan
Fuses		1x40 A	2x40 A		10x30 A
Connection for remote control	no	no	no	yes	yes
USB	yes	yes	yes	yes	yes
Socket	1	1	1	1	1
Dimensions (WxHxD) in mm	145x76x54	195x102x55	235x102x55	275x208x77	345x230x108
Weight	0.40 kg	0.63 kg	0.83 kg	2.5 kg	5.3 kg
<b>Art. no.</b>	<b>82290</b>	<b>822810</b>	<b>822801</b>	<b>822804</b>	<b>822803</b>
<b>Price</b>	<b>35,90</b>	<b>62,20</b>	<b>71,40</b>	<b>141,-</b>	<b>326,-</b>



## Priority circuit for converters up to 2300 watts

Automatically switches between shore power supply and power from the converter. As soon as external current is connected, e.g. from the campground, the converter operation is interrupted. Without external current the converter switches on again to supply the 230 V consumers. There is a 2nd high-load output that functions only when external current is connected (e.g. for operating chargers or air conditioners). This prevents overloading of the converter. **82192**                      **119,-**

# Converter with sine-wave voltage for sensitive 230 V devices

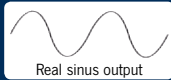

**12V 230V**

- Extremely high starting current, up to 3x higher power
- Convert 12 volt battery current to 230 volt
- No restrictions of use, suitable for measuring computers or microwave ovens
- We recommend the 2000 watt converter for operating many air conditioners
- Switch-mode technology:  
Very quiet – lightweight & compact
- Undervoltage circuit breaker protects battery
- Excess temperature circuit breaker (ca. 60 °C)
- Reverse polarity protection, overload protection
- Approved for installation in motor vehicles (e-mark\* & CE certified)
- 12 V connecting cable, 2 m (except PS300U) included



Tested with Dometic FreshJet 2200 air conditioner



Watch video



Tested with Nespresso® capsule machine



Watch video

## Automatic load detection–

The converter switches to energy-saving mode after one minute with no power draw.

**Fan** – At excess temperatures the built-in temperature-controlled fan automatically switches on.

**Aluminium enclosure** – Suitable for floor or wall mounting.



## Suitable cable remote controls

For ① with 4.5 m cable

**81949 27,20**

For ② ③ ④ ⑤ with 5 m cable

**81948 27,20**

Illustration	①	②	③	④	⑤
<b>Type</b>	<b>PS300U</b>	<b>PS700U</b>	<b>PS1000U</b>	<b>PS2000U</b>	<b>PS3000U</b>
Input voltage DC	12 V	12 V	12 V	12 V	12 V
Continuous power	300 W	700 W	1,000 W	2,000 W	3,000 W
Rated power	300 W	700 W	1,000 W	2,000 W	3,000 W
Peak power, temp.	600 W	2,100 W	3,000 W	6,000 W	9,000 W
Output voltage (±5%)	230 V	230 V	230 V	230 V	230 V
Shut-off threshold / undervolt.	10.0±0.5 V		10.0±0.5 V	10.0±0.5 V	10.0±0.5 V
Steady current	<1 A		<2 A	<2.2 A	<2.5 A
Efficiency	>90%		>90%	>90%	>90%
Connection for remote control	yes	yes	yes	yes	yes
USB connection / ampere	yes	yes / 2.1 A	yes / 1 A	yes / 1 A	yes / 1 A
Socket	1	1	1	1	1
Connecting cable included	no	2 m, 16 mm <sup>2</sup>	2 m, 25 mm <sup>2</sup>	2 m, 50 mm <sup>2</sup>	2 m, 50 mm <sup>2</sup>
Dimensions (WxHxD) mm	260x150x58	255x186x90	317x186x90	320x152x105	475x251x105
Weight	1.6 kg	2.0 kg	3.0 kg	4.8 kg	6.5 kg
<b>Art. no.</b>	<b>82281</b>	<b>82285</b>	<b>82282</b>	<b>82283</b>	<b>82284</b>
<b>Price</b>	<b>130,-</b>	<b>261,-</b>	<b>392,-</b>	<b>708,-</b>	<b>926,-</b>

# Dependable chargers

10A



Suitable for LiFePO4 batteries

## Battery charger 10 A

3-stage charging, selectable battery type, also suitable for LiFePO4 batteries, incl. connection cable and battery terminals, weight ca. 1.4 kg L 130x150x50 mm

80280 90,50

20A



## Battery charger 20 A

3-stage charging, selectable battery type, also suitable for LiFePO4 batteries, incl. connection cable and battery terminals, weight ca. 2 kg L 160xW 150xH 70 mm

80281 115,-

Suitable for LiFePO4 batteries

## Smart Charger Ultra 20 A

- For gel, AGM, LiFePo4 (Li-high / normal), Calcium and lead acid batteries
- Connection for CBE control panel 200
- Temperature-controlled fan
- Overload / underload, short-circuit and overheating protection
- Sturdy aluminium housing with good heat dissipation
- DIP switch for setting the battery type
- IUoU charge characteristic for optimal battery charging

Max. charging capacity 12 volt / 20 A, charge outputs / characteristic curve: 1 / IUoU + panel connection, recommended battery capacity 40 – 200 Ah, fan cooling: Temperature-controlled fan, Bulk (end-point voltage) 14.2 / 14.6 / 14.9 / 15.0 V DC, Float (conservation) 13.2 / 13.5 / 13.8 / 14.6 V DC, input voltage 50/60 Hz: 120 to 230 V AC +/- 15% 50/60 Hz, output short-circuit proof, LED power indicator, operating temperature – 40 to + 50 °C, L 298xH 120x W 96 mm, weight 1.5 kg

800801 217,-

Temperature sensor optional for Smart Charger Ultra (similar to illustration)

Includes 1 m connection cable 800802 17,40



NEW

## Intelligent 6/12 V battery charger

- LCD display
- Diagnostic and regeneration function
- For all 6/12 V batteries (AGM, gel, wet cell)
- Microprocessor, 5-stage charging program
- Controlled trickle charge

Microprocessor-controlled charger with 4.0 ampere charging capacity. Technical data: Protection type IP65 Battery capacity: max. 120 Ah.

Input voltage: 220 – 240 V AC / 50 Hz, max. 70 W. Output voltage: max. 14.7 V DC / 4.0 A. Dimensions: (LxWxH) 18x8x5 cm.

Weight: 0.5 kg. 819010 39,30







# Professional charging technology from 10 to 40 A



- Automatic operation
- High efficiency with 4-stage charging
- Electronic, battery-saving charging
- Selectable battery type (gel, acid, AGM)
- Short circuit proof charge outputs
- Reverse polarity protected charge outputs
- Overcharge protection
- Aluminium enclosure for optimal heat dissipation
- Perfect charging characteristic for Reimo GreenPower AGM batteries

## Intelligent battery charger with 4-stage switch-mode technology

Overcharge protection included. The SMART Charger can charge your battery faster than many other conventional chargers. The compact design facilitates installation in RVs, caravans and boats. It can be used for charging acid, gel or AGM batteries. Built-in LEDs indicate the different functions. Connecting the optional panel makes it possible to check the charge state at any time, in case of concealed installation.

**1<sup>st</sup> stage:** The battery is charged with high current and “regenerated”. This ensures that the battery is always fully charged (max. duration: 30 minutes).

**2<sup>nd</sup> stage:** The battery is charged with the charger’s maximum current until the battery has reached absorption voltage. The absorption voltage can be selected for different battery types. (V parameters: 14.2 / 14.6 / 14.8 V DC)

**3<sup>rd</sup> stage:** The charge current is reduced gradually while increasing the battery voltage. To protect the battery (overcharging) the 3<sup>rd</sup> stage is limited to 6 hours.

**4<sup>th</sup> stage:** The battery is charged to about 85 % of its capacity. The charge current is reduced and kept at a constant level until fully charged. The voltage can be set by selecting the battery type (Acid/GEL/AGM). (Non-binding information from manufacturer)



AGM setting suitable for many lithium batteries.

Model type	BC-1210SCT	BC-1215SCT	BC-1220SCT	BC-1225SCT	BC-1230SCT	BC-1240SCT
Charge power, max.	10 A	15 A	20 A	25 A	30 A	40 A
Independent charge outputs	1*	1*	2	2	2	2
Recommended battery capacity	20 – 100 Ah	30 – 150 Ah	40 – 200 Ah	50 – 250 Ah	60 – 300 Ah	80 – 400 Ah
Recommended cable diameter	2.5 mm <sup>2</sup>	4 mm <sup>2</sup>	4 mm <sup>2</sup>	4 mm <sup>2</sup>	4 mm <sup>2</sup>	6 mm <sup>2</sup>
Fan cooling	No fan	Temperature-controlled fan				
Bulk (end-point voltage)	14.2 / 14.6 / 14.8 V DC					
Float (conservation)	13.2 / 13.5 / 13.8 V DC					
Input voltage 50/60 Hz	230 V AC +/- 5% 50 Hz / 60 Hz					
Output short-circuit proof	yes	yes	yes	yes	yes	yes
LED display	Green: power indicator, green: float, yellow: absorption: red: bulk charging					
Operating temperature	0 – 40 °C					
Dimensions (mm)	210x145x80	210x145x80	240x145x80	240x145x80	290x145x80	320x145x80
Weight (g)	1034	1067	1275	1315	1686	1888
Art. no.:	80293	80294	80295	80296	80297	80298
Price	163,-	196,-	239,-	272,-	326,-	392,-

\*1 parallel charge output for 2 batteries of the same type, age and capacity (e.g. identical on-board batteries), not for simultaneous charging of on-board and started battery.

# CEE plug and cable for professional use



## CEE angle plug

For no-kink connection to the power column or electrical outlet

820302 7,65



## CEE connector

Suitable for connection to CEE input sockets

82032 4,90



## CEE plug

Suitable for CEE connection socket on campgrounds and CEE sockets

82031 4,35



## CEE/Schuko adapter

CEE connector with cover

82007 10,40



## CEE angle connector

CEE 17 European connector with integrated Schuko socket and hinged cover, suitable for CEE input sockets

82030 8,50



## Plug for Switzerland

to CEE connector, 10 A, H=7RN-F cable 3x2.5 mm<sup>2</sup>

0.4 m 821541 27,30  
1.5 m 821544 28,40



## CEE plug

to socket Switzerland, H=7RN-F cable 3x2.5 mm<sup>2</sup>

0.4 m 821542 26,20  
1.5 m 821545 19,70



## Plug for GB

to CEE connector, H=7RN-F cable 3x2.5 mm<sup>2</sup>. Ca. 20 A

0.4 m 821543 10,90  
1.5 m 821546 14,20



## 2-way distributor

CEE plug/ 2-way CEE distributor socket with hinged cover

82301 15,30



## Schuko/CEE adapter

CEE plug/ Schuko connector with cover

82044 18,60



## CEE surface-mounting input socket

Ideal for concealed installation under the hood (e.g. in T5) with cover, 3-terminal 230 V/ 16 A

82008 9,70



## CEE socket

for permanent installation. With hinged cover, plastic. For power supply on campgrounds or in garages, carports etc.

82091 9,60



## CEE safe box

Protects contents from moisture. With lock, L 365 mm, Ø 100 mm

820432 10,70



## Schuko/angle adapter

Schuko plug/ CEE angle connector with additional Schuko socket. Prevents kinking of the cable. H07 RN-F 3x2.5 mm<sup>2</sup>.

1.5 m 82020 16,40  
25 m 820201 76,30  
H07 RN-F 3x1.5 mm<sup>2</sup>  
(for export only) 82025 14,20



## CEE/Schuko adapter

CEE plug/ Schuko rubber connector H07RN-F 3x2.5 mm<sup>2</sup> incl. carrying case

1.5 m 82022 13,10  
0.4 m 820221 10,90  
H07 RN-F 3x1.5 mm<sup>2</sup>. 0.4 m  
(for export only) 820261 9,80



## Schuko/CEE adapter

Schuko plug/ CEE connector \*also suitable for France H07RN-F 3x2.50 mm<sup>2</sup>, incl. carrying case

0.4 m\* 820211 14,20  
1.5 m 82021 16,40  
4.0 m\* 820212 21,80  
25 m\* 820213 63,30

Cables with a size of 3 x 1.5 mm<sup>2</sup> are not approved for outdoor use in Germany!

# Professional CEE cable drum for numerous applications

① **CEE cable drum** 3-terminal CEE plug (on the drum) and CEE connector (on short end). Campground approval up to 25 m. 16 A, H07 RN-F 3x2.5 mm<sup>2</sup>. 25 m **820481 85,10**

② **CEE cable drum** H07 RN-F 3x2.5 mm<sup>2</sup>. 2 Schuko/ 1 CEE socket, thermal protection switch. 25 m **82027 99,90**

③ **CEE cable drum** 3-terminal CEE plug (on the drum) and CEE right-angled socket and Schuko socket (on short end). Campground approval up to 25 m. 16 A, H07 RN-F 3x2.5 mm<sup>2</sup>. 25 m **820483 92,70**



**Our accessory recommendation:**  
 Cable transport bag **820292**  
 Cable tie with handle **820091**  
 Manual cable drum **82009**  
 (See page 37)



## CEE extension cable

Neoprene rubber cable. Transport bag included. Suitable for outdoor use. Carrying bag included  
 H07RN-F. 3x2.5 mm<sup>2</sup>  
 10 m **82018 38,20**  
 25 m **820181 68,70**  
 H07RN-F. 3x1.5 mm<sup>2</sup>  
 (for export only)  
 10 m **82024 26,20**  
 25 m **820242 56,70**  
 40 m (without bag) **820244 87,20**



## CEE plug / angle connector

With additional Schuko socket. 3x2.5 mm<sup>2</sup>  
 1.5 m **82036 21,80**  
 15 m **820362 54,50**  
 25 m **820361 76,30**  
 With additional Schuko socket.  
 3x1.5 mm<sup>2</sup> (for export only)  
 20 m **82204 43,60**  
 30 m **822041 63,30**



## USB connection cable

CEE plug / connector, 3x2.5 mm<sup>2</sup>, length: 1.5 m. **82035 16,40**



## 3-way power strip

With three Schuko sockets and hinged covers, 10 m connection lead + CEE plug, 25 A automatic cut-out. In plastic housing with mount for hanging. 2 terminals Ø21 mm for clipping to tent pole.  
 3x1.5 mm<sup>2</sup> (for export only)  
 10 m **82210 65,40**



## 3-way power strip

With three Schuko sockets and hinged covers, 10 m connection lead with CEE plug. Plastic housing. H07 RN-F 3x2.5 mm<sup>2</sup>.  
 10 m **82208 43,60**  
 Like 82208 but with 3x1.5 mm<sup>2</sup> (for export only)  
 1.5 m **82209 19,70**  
 5 m **822091 21,80**

Cables with a size of 3 x 1.5 mm<sup>2</sup> are not approved for outdoor use in Germany!

# 12 V SMD LED technology

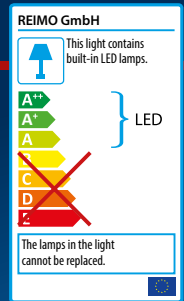

Valid for all lights on this page.

**A++**

**Flat panel S, M, L**

① Type S, 6xSMD, 1.5 watt, 120 lm, angle 120°, Ø26x8 mm, socket G4, pins on back. **830323 6,45**

② Type M, 12xSMD, 2 watt, 170 lm, angle 120°, Ø30x8 mm, socket G4, pins on back. **830324 6,45**

③ Type L, 15xSMD, 3 watt, 200 lm, angle 120°, Ø35x8 mm, socket G4, pins on back. **830325 7,55**

④ Type S, 9xSMD, 1.5 watt, 120 lm, angle 120°, Ø25x8 mm, socket G4. **8303260 7,55**

**A+**

**Pin base LEDs**

① 4xSMD, 1.5 watt, 60 lm, angle 120°, socket G4, Ø11.2xH23.5 mm. **830320 6,-**

② 6xSMD, 1.2 watt, 90 lm, angle 120°, B18xH27.5 mm, socket G4. **830321 6,45**

③ 15xSMD, 1 watt, 82 lm, angle 300°, Ø12xH22 mm, socket G4. **830322 5,35**

**A++**

**Flat panel S, M, L**

① Type S, 9xSMD, 1.5 watt, 120 lm, angle 120°, Ø25x8 mm, socket G4. Terminals on side. **830326 6,45**

② Type M, 9xSMD, 1.5 watt, 150 lm, angle 120°, Ø27x8 mm, socket G4. Terminals on side. **830327 7,55**

③ Type L, 2xSMD, 3.0 watt, 270 lm, angle 120°, Ø35x8 mm, socket G4. Terminals on side. **830328 7,55**

**A++**

**LED tubular lamps**

① 3xSMD, 0.60 watt, 48 lm, angle 120°, Ø36x9.8 mm, socket SV8.5. **830333 5,35**

② 6xSMD, 1.2 watt, 87 lm, angle 120°, Ø37x10 mm, socket SV8.5. **830334 6,55**

③ 6xSMD, 1.5 watt, 110 lm, angle 120°, Ø36x16 mm, socket SV8.5. **830335 8,75**

**A++**

**LED BA9S**

0.89 watt, 31 lm, angle 180°. Socket BA9S. **830371 9,70**

**A++**

**LED lamp BA15S**

Material: glass, 16xSMD, 0.7 watt, 60 lm, angle 300°, Ø51x25 mm, socket BA15S. **830911 7,55**

**NEW**

**A++**

**LED lamp BA15S**

Material: glass, 16xSMD, 0.7 watt, 60 lm, angle 120°, Ø48.5x24.5 mm, socket BA15S. **830338 8,75**

**NEW**

**A++**

**LED lamp BA15S**

Material: aluminium, 18xSMD, 2.5 watt, 220 lm, angle 120°, Ø22x54 mm, socket BA15S. **830339 8,65**

# 12 V COB LED technology of the latest generation

**A++**

**G4-COB bulb 1.5 watt**

① 1xCOB-LED, 12 V, 1.5 watt, socket G4, COB bulb, silicon, 3,000 K, 90-100 lm, not dimmable, IP20, angle 220°, dimensions: Ø10x22 mm. **830329 7,65**

② 2xCOB-LED, 12 V, 1.5 watt, socket G4, COB bulb, 3,000 K, 120 lm, not dimmable, IP20, angle 360°, dimensions: 10x40 mm. **830330 6,55**

**A++**

**G4-COB bulb, 2 watt**

1xCOB-LED, 12 V, 2 watt, socket G4, COB bulb, silicon, 3,000 K, 200 lm, not dimmable, IP20, angle 360°, Ø10x30 mm. **830331 9,70**

**A++**

**G4-COB bulb, 5 watt**

5xCOB-LED, 12 V, 5 watt, socket G4, COB bulb, aluminium, 3,000 K, 400 lm, not dimmable, IP20, angle 120°, dimensions: W15.3xH33 mm. **830332 9,70**

# Professional Schuko 230 volt accessories



## Plug / connector

- ① Schuko rubber connector self-service pack.  
**82033 3,30**
- ② Schuko rubber connector Self-service package.  
**82034 4,70**



1.5 m cable

## Schuko distributor

- Extension distributor Schuko / Schuko**  
 Schuko plug to double Schuko socket. With 1.5 m cable and 2 caps. H07 RN-F 3x2.5 mm<sup>2</sup>.  
**82006 9,80**



## Cable drum with 4 sockets

- Rubber cable with Schuko plug and 4 Schuko sockets with cover. For indoor use. Self-service package, splash-proof. H05 RR-F 3x1.5 mm<sup>2</sup> (for export only)  
 25 m **820451 41,50**



## Cable drum with 4 sockets

- Rubber cable with Schuko plug and 4 Schuko sockets with cover. For indoor use. Self-service package, splash-proof. H05 RR-F 3x1.5 mm<sup>2</sup> (for export only)  
 7.5 m **82153 19,70**



## Power strip

- Schuko plug to Schuko power strip with hinged caps. For indoor use. With 2.5 m cable, H05 RR-F 3x1.5 mm<sup>2</sup>.  
**5-way 82151 16,40**  
**4-way 82152 15,30**



## Schuko extension cord

- Length: 5 or 10 m, with Schuko plug and Schuko connector, neoprene rubber cable. For outdoor use. H07 RN-F 3x2.5 mm<sup>2</sup>  
**5 m 820191 17,50**  
**10 m 82019 30,60**



## Schuko safe box

- Protects contents from moisture. Box without lock, L 210xØ 70 mm.  
**820431 4,35**



## Schuko adapter with USB

- Schuko socket adapter with 2x USB charge ports, input: AC85–265V 50/60 Hz, output: DC5V–2.1 A (max.)  
**82302 8,75**



## Manual cable drum

- for rolling up and extension cable with a max. length of 35 m, cable 2.5 mm<sup>2</sup>  
**82009 10,90**



## Cable transport bag

- For convenient cable transport. Suitable for manual cable drum (art. no.: 82009). Size: Ø 40 cm, width: 14 cm.  
**820292 13,10**



## Cable tie with handle

- For bundling, carrying and stowing – reusable. Suitable for 25 m cable (H07 RN-F 3G 2.5) or for 40 m cable (H07 RN-F 3G 1.5).  
**820091 5,45**



## Schuko distributor plug

- ① **2-way socket with hinged caps 82201 6,55**  
 ② **3-way socket with 1.5m cable With hinged caps. H07 RN-F 3x2.5 mm<sup>2</sup>. 82202 14,20**

Cables with a size of 3x1.5 mm<sup>2</sup> are not approved for outdoor use in Germany!

# Powerful COB LED lights



## ① Battery-operated camping light

Powerful 3 W COB camping light (500 lumens), battery-operated (3x D batteries not included), dimensions: 82x82x182 mm, weight: ca. 394 g, battery charge life: ca. 4 h

**834872 29,40**

## ② Solar / 230 V / 12 V large camping light

Battery-powered LED tent lantern with integr. solar panel. Charge via solar, 230 V or 12 V adapter. With 5 V / 1 A USB port for charging mobile phones and other devices. Extremely bright with 600 lumens, 4,000 mAh battery for very long charge life. 3 brightness settings: very bright (ca. 2 h), bright (ca. 6 h) and flashing mode. Dimensions: D: 125xW: 125xH: 250 mm.

**83487 54,40**

## ③ Solar / 230 V / 12 V small camping light

Battery-powered LED tent lantern with integr. solar panel. Charge via solar, 230 V or 12 V adapter. With 5 V / 1 A USB port for charging mobile phones and other devices. 500 lumens, 4,000 mAh battery for very long charge life. 3 brightness settings: very bright (ca. 4 h) and flashing mode (ca. 8 h). Dimensions: D: 82xW: 82xH: 182 mm.

**834871 49,-**

## ④ COB multi-function pen light

Battery operated (3x AAA). Ear piece clip, ultra-bright LED, with loop

**83528 8,75**



**15W POWER**  
**450/1200 LUMEN**  
**COB LED**  
**4000 mAh**

## Rechargeable COB multi-function spotlight

4,000 mAh 15 W battery, robust aluminium housing and adjustable base. Luminosity: ca. 800 lumens (stage 1), ca. 450 lumens (stage 2), scope of delivery: radiator with base, 12 V + 230 V charging cable, charge time: ca. 6 h, battery life: ca. 1.5 h (level 1), 5 h (level 2)

**83492 65,30**

**SMD LED**  
**30 LUMEN**  
**COB LED**  
**120 LUMEN**  
**3W POWER**  
**CLIP FUNCTION**  
**3x AAA BATTERIES**



## COB clip-on light

3 W COB + 1 SMD LED, 120 lumens + 30 lumens, 3xAAA batteries (not included), 2 strong magnets on back, clip-on function, with joint for optimal adjustment

**83490 10,80**



**3x AAA BATTERIES**

## COB head torch with touch function

Very luminous with 200 lumens, 3 W, 3x AAA batteries (not included), adjustable headband and touch switch

**83491 7,30**



**3x AAA BATTERIES**

## COB torch and workshop light

Very bright COB light for many different uses. Very strong magnets on back. For use on metal surfaces. Rotates 360°.

With spring hook. 150 lumens. 3x AAA batteries (not included).

**83488 10,80**

# LED flex strips with warm white, RGB or blue light

- Atmospheric lighting for indoors / outdoors
- All LED flex strips are dimmable
- Self-adhesive, can be shortened after ever 3<sup>rd</sup> or 6<sup>th</sup> LED

**12 V LED Topview flex strip for indoor & outdoor use**  
30 LEDs/m, 2.4 W/m, 195 lumens/m, 3,000 K, IP66, warm white, 5 m roll, strip width: 7 mm

**83174 25,-**

**12 V LED Topview flex strip for indoor & outdoor use**  
60LEDs/m, 4.8 W/m, 390 lumens/m, 3,000 K, IP67, warm white, 5 m roll, strip width: 7 mm

**83171 43,50**

**12 V LED Topview flex strip for indoor & outdoor use**  
120 LEDs/m, 9.6 W/m, 780 lumens/m, 3,000 K, IP67, ideal as awning lighting, incl. 1 m connection cable (waterproof), warm white, 5 m roll, strip width: 10 mm

**83170 70,80**

**12 V LED Topview flex strip for indoor use**  
60 LEDs/m, 4.8 W/m, 390 lumens/m, 3,000 K, IP20, warm white, 5 m roll, strip width: 5 mm

**83172 32,60**

**12 V LED Sideview flex strip with sideways illumination**  
60 LEDs/m, 7.2 W/m, 660 lumens/m, 3,000 K, IP67, warm white, 5 m roll, strip width: 10 mm

**83173 76,30**

**12 V LED flex strip RGB and warm white in one**  
72 LEDs/m, can be shortened after every 6<sup>th</sup> LED, 10.8 W/m (all LEDs incl. warm white), 2.2 W/m (only warm white LEDs), 280 lumens/m (only warm white LEDs), 72 lumens/m (only red), 138 lumens/m (only green), 35 lumens/m (only blue), warm white 3,000 K, 5 m roll, strip width: 10 mm, dimmable

**83175 76,30**

#### Control unit with remote control

Especially for RGBW LED flex strip 83175. For controlling light effects and colour.

**83179 27,20**

**12 V LED RGB flex strip for indoor & outdoor use**  
60 LEDs/m, 4.8 W/m, 120 – 140 lumens/m, IP68, 5 m roll, strip width: 8 mm, incl. 10 mounting clips and 20 end caps

**831008 46,40**

#### RGB control unit with remote control

Especially for RGBW LED flex strip 831008. For controlling light effects and colour.

**831009 12,30**

**12 V LED Blue flex strip for indoor & outdoor use**  
60 LEDs/m, 4.8 W/m, 40 – 45 lumens/m, IP68, 5 m roll, strip width: 8 mm, incl. 10 mounting clips and 20 end caps

**831007 54,50**

#### 12 volt dimmer with remote control

For single-colour LED strips or dimmable lights for controlling the brightness via remote control. Ideal for retrofitting of awning lights, since no additional switch must be installed. Functions: brighter/darker, On/Off. Up to max. 96 watts, steady current ca. 30 mA. Dimensions: L 90xW 60xH 37 mm.

**831003 21,80**



RGBW control unit & remote control (83179)



RGB control unit & remote control (831009)



Fig. shows flex strip with LEDs in RGB and warm white (83175)

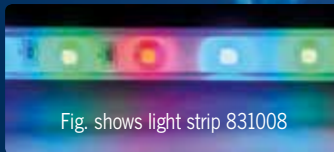

Fig. shows light strip 831008



Fig. shows light strip 831007

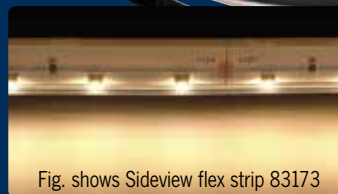

Fig. shows Sideview flex strip 83173



Fig. shows Topview flex strip



Valid for all LED flex strips on this page.

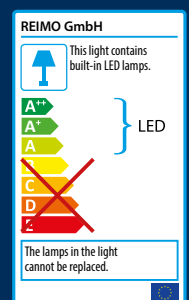

# Stylish Carbest aluminium profiles for all LED flex strips with a width of 10 mm

- Custom light design for ambient lighting
- Suitable for Carbest LED flex strips with a width of 10 mm
- Profile length: 1.5 m
- Perfect combination of furniture panels and furniture elements

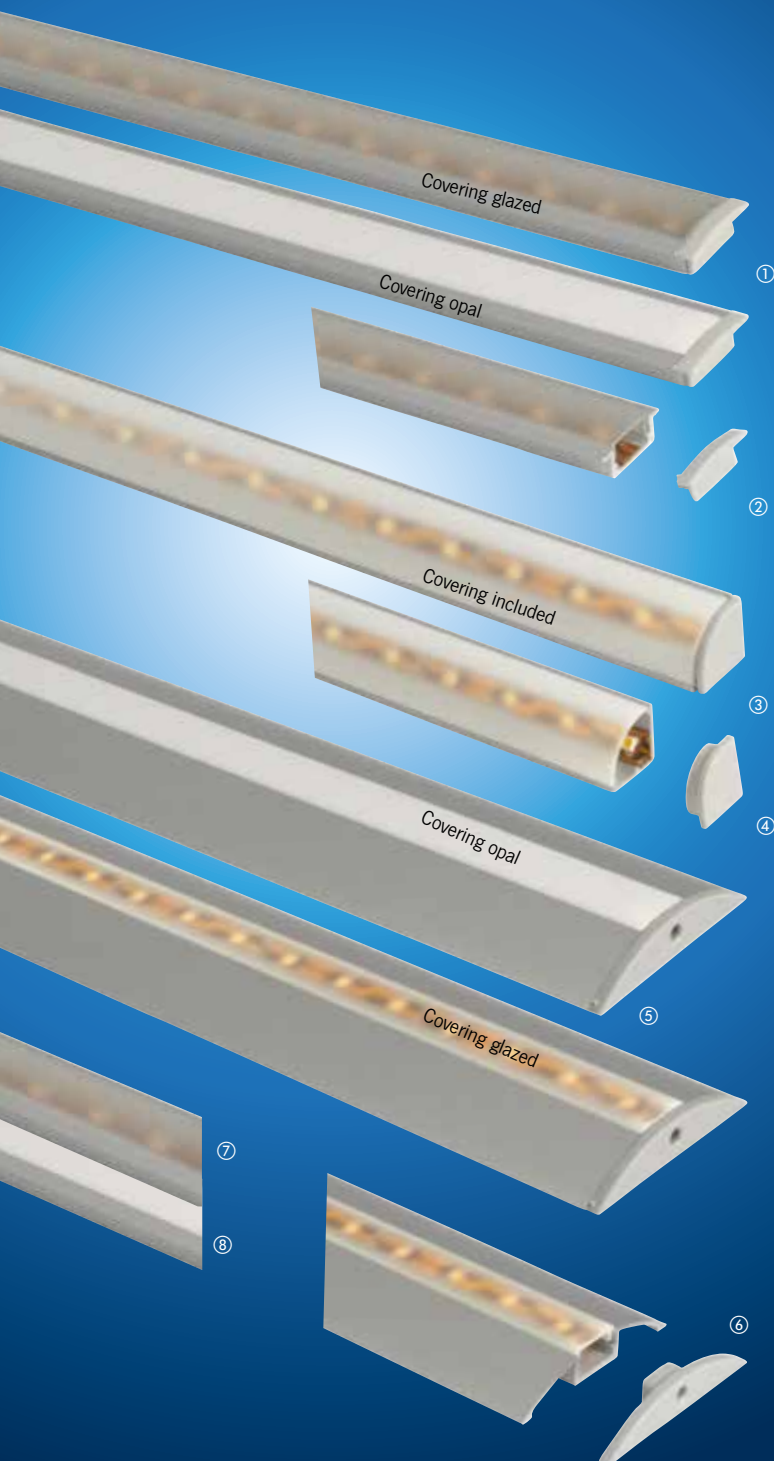

These aluminium profiles provide a professional solution for the installation of LED strips. With the profiles and the LED strips on the left side you can easily create your own light designs. The profiles are ideal for use in building furniture, for example to cover the transition between different wood panels or to provide stylish lighting. You can create custom lighting for perfect integration in the furniture. For example, corners and areas under cabinets and shelves can be accented with light effects. For light scattering you have the choice between the semi-transparent glazed covering or the opal version, which appears white. Each set includes 2 end caps, and you can add more caps as desired. Strip width: 10 mm. All aluminium profiles are delivered WITHOUT LED flex strips.

- |   |               |              |
|---|---------------|--------------|
| ① Set, flat aluminium profile, 2 end caps included.<br>For surface mounting or recessed mounting in a groove.<br>Length: 1.5 m                            | <b>82999</b>  | <b>10,90</b> |
| ② End caps (2 pieces) for 82999   | <b>82980</b>  | <b>1,10</b>  |
| ③ Set, angled aluminium profile, 2 end caps included.<br>For mounting in corners and under cabinets. Length: 1.5 m.                                       | <b>829991</b> | <b>16,40</b> |
| ④ End caps (2 pieces) for 829991  | <b>82981</b>  | <b>2,20</b>  |
| Mounting clips (2 pieces) for 829991 (not shown)  | <b>829810</b> | <b>2,20</b>  |
| ⑤ Set, semi-round aluminium profile, 2 end caps included.<br>For screwing on and covering transitions of furniture panels,<br>for example. Length: 1.5 m. | <b>829992</b> | <b>16,40</b> |
| ⑥ End caps (2 pieces) for 829992  | <b>82982</b>  | <b>2,20</b>  |
| ⑦ Cover<br>Length: 1.5 m, for 82999 / 829992 glazed (semi-transparent).   | <b>82983</b>  | <b>6,90</b>  |
| ⑧ Cover<br>Length: 1.5 m, for 82999 / 829992 opal (white).  | <b>82984</b>  | <b>6,90</b>  |



# 12 V LED area lights for walls and ceilings



## Super flat LED panel

- Only 5 mm thick – super flat
- Stylish silver coloured frame
- Warm white light with 3,000 K
- Energy efficiency A+

① 12 V/9 W 100x300 mm	833692	41,50
② 12 V/6 W 100x200 mm	833691	36,-
③ 12 V/3 W 100x100 mm	83369	23,90
④ LED area light for walls and ceilings		

Plastic, white, 12 V, 5 watt, 350 lm, 33 SMD LEDs. Colour temperature 3,000 K, angle of radiation 180°.

70x70x14.5 mm	830341	19,70
130x130x14.5 mm	830342	29,50

## LED with night light function

- With blue night light
- 36 warm white and 12 blue LEDs
- LED with touch switch and switchable blue night light
- Energy efficiency A+

⑤ Plastic, chrome and silver coloured. 12 V/5.5 W, 3,200 K, 550 lm, radiation angle 120°. Dimensions: Ø 129 mm, H9 mm

83572	52,40
-------	-------

⑥ Plastic, chrome and white. 12 V/5.5 W, 3,200 K, 550 lm, radiation angle 120°, dimensions: 129x129x9 mm

83573	54,50
-------	-------

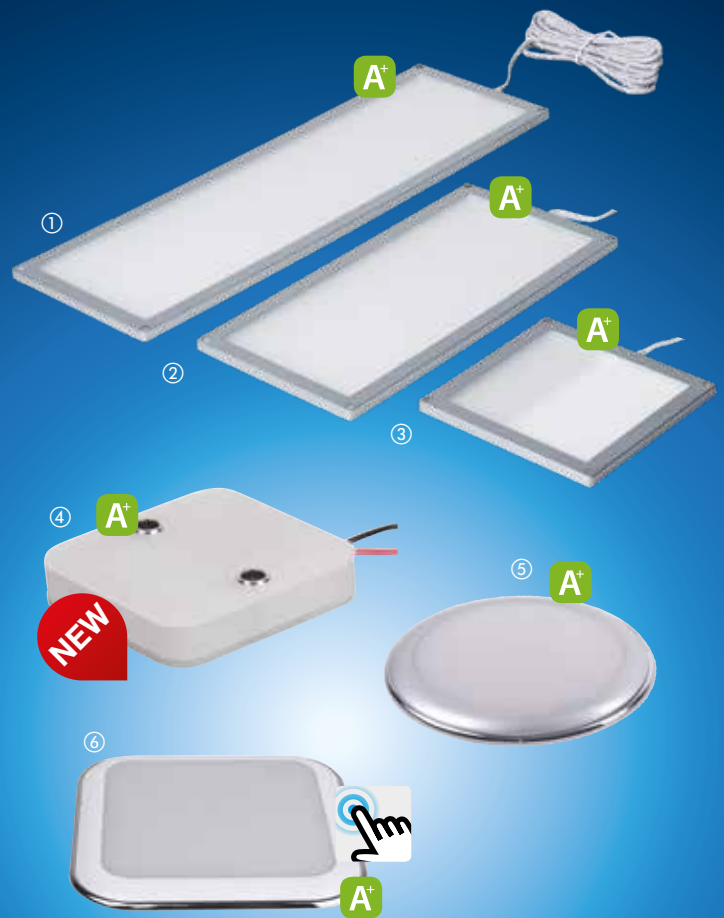

# Exquisite 12 V reading lights with innovative On/Off switch

Reading light of brushed nickel in two different lengths dimmable if additional dimmer is present.

Ø 35 mm, 12 V, 1.2 watt, warm white (3,000 K), 100 lm, radiation angle 90°. Life cycle ca. 20,000 hours, energy efficiency class A+.

Total height 160.5 mm	830343	37,10
Total height 300.5 mm	830344	41,50



ON/OFF SWITCH  
INTEGRATED IN HEAD



# Carbest reversing monitor can be combined with a camera



## Top View 7" reversing monitor

7" TFT monitor, resolution 800x480 pixels. **Can be combined with the 3 cameras below: 47801, 47802, 47803.** With mirror function and integrated speakers. 9 watt power output, 2 camera connections. Temperature range -10 °C to +65 °C. Scope of delivery: Connecting cable, mount, instructions and remote control. **47804 163,-**

## Adapter cable

For connecting a camera to navigation systems. Suitable for all cameras on this page. **47808 7,55**



## Easy Eye night vision compact infrared camera

Night vision compact camera with heating. Resolution: 500x582 pixels, 0 lux, 18 night vision LEDs, viewing angle 120°, voltage: 12 volt, temperature range: -20 bis 70 °C. Scope of delivery: Camera, 20 m connection cable, user manual and fastening material. **47802 185,-**



## Full Eye reversing double camera

Double lens camera with integrated microphone and heating. Resolution: 500x582 pixels, 0 lux, 15 night vision LEDs, viewing angle 120°/45°, voltage: 12 V, temperature range: -20 bis 70 °C. Scope of delivery: camera, 20 m connection cable, user manual and fastening material. **47801 250,-**



## Van View reversing infrared camera for box vans with a split rear door

Ideal for the vehicle roof edge of box vans and transporters with a split rear door. Resolution: 500x582 pixels. 0 lux, 9 night vision LEDs, viewing angle 120°, voltage: 12 V, temperature range: -20 bis 70 °C. Scope of delivery: camera, 20 m connection cable, user manual and fastening material. **47803 207,-**

# Carbest Profi-View reversing cameras for retrofitting



Approved for operation and use in motor vehicles on all European roads!

- For retrofitting in existing navigation systems
- 3 camera types to choose from
- Automatically switches on when shifting to reverse
- AV-cinch adapter for connection to all devices with a cinch input (e.g. for all ZENEC, XZENT Moniceiver / Naviceiver etc ...)
- 20 m camera cable



## ① Colour camera, electric rotating

Ideal for driving with a trailer. With 20 m cable.

471890 217,-

## ② Reversing camera with electrically controlled cover (shutter camera)

The camera cover closes electrically to protect the camera lens from snow, water and dirt. With 20 m cable.

471894 250,-

## ③ Double lens camera with 2 objectives

Ideal for use with trailers and for manoeuvring. With integrated wiper for a clear view, and 20 m connecting cable.

471888 490,-

## Camera connection adapter

For connection to existing Moniceiver / Naviceiver systems.

Suitable for the Carbest camera 471890

471882 27,30

Suitable for the Carbest camera 471894

471882 27,30



## Replacement windscreen wiper

For the double lens camera 471888

471880 15,80



## Camera connection adapter

For connection to existing Moniceiver / Naviceiver systems. Suitable for the Carbest camera 471888.

471990 46,80



# Carbest Profi-View reversing complete system



Approved for operation and use in motor vehicles on all European roads!



## Complete system with colour camera and 7" monitor

- Camera rotates up to 40°
- Low-reflection monitor with speaker and sun shade
- Sensor-controlled monitor brightness
- Automatically switches on (when shifting to reverse)
- Monitor mount for gluing or bolting
- 1 x additional AV input

471892 544,-

## Complete system with double lens camera and 7" monitor

- Camera with heating, electric shutter and "windscreen wiper"
- Low-reflection monitor with speaker and sun shade
- Sensor-controlled monitor brightness
- Automatically switches on (when shifting to reverse)
- Monitor mount for gluing or bolting
- 1 x additional AV input

47188 817,-

Set	Set with colour camera	Set with double lens camera
Article number	471892	47188
Resolution of monitor / camera (pixels)	480x234 (RGB) / 320,000	480x234 (RGB) / 330,000
Viewing angle / horizontal / vertical	Cam: 130° / pivoting angle 40°	Cam 1: 150° / Cam 2: 53°
Infrared night vision LED / sensitivity	yes / (1.5 lux)	no / (0 lux)
Microphone in camera / heating in camera	yes / no	no / yes
Operating voltage	12 – 32 V DC	12 V DC
Temperature range of monitor / camera	- 10 to + 50 °C / - 30 to + 50 °C	- 10 to + 50 °C
Technical data for monitor	7" TFT LCD display, TV system PAL/NTSC, max. power draw 12 W, 1 camera input, 1 AV output (cinch). Weight ca. 480 g, dimensions in mm (WxHxD), without mount: 190x125x28	
Technical data for camera	1/3" CCD colour sensor, electronic aperture, dimensions: W95xH53xD78 mm, weight ca. 500 g. case: black	CCD colour camera, weight ca. 650g, aluminium case, protection type IP68, heating, dimensions in mm (WxHxD): 118x57x59
Scope of delivery	7" LCD TFT colour monitor with integrated speaker, hinged mount and glare shield, monitor connection cable, 20 m connection cable between camera and monitor.	

# 12 V wireless reversing camera systems

- Immune to noise, range: ca. 32 m
- 2-channel video, split-view, audio
- Dust- and waterproof
- Vibration-resistant

## Technical data for 7" LCD monitor:

2.4 GHz, resolution: 800x480, contrast: 500:1, viewing angle: V:110°, H:140°, input voltage: 10 – 16 V, video system: PAL and NTSC, image: 4:3/16:9, brightness: 450 cd/m<sup>2</sup>, adjustable universal mount, operating temperature: – 30 °C to + 70 °C, operating voltage: 10 – 36 V

## Technical data for camera:

Colour sensor, waterproof acc. to IP69K, video system: NTSC 720x480, PAL 756x504, resolution: 600 TV lines, minimum light requirement: 0 lux (LED, 12 IR), shutter speed: 1/100,000(s), vibration-resistant, angle of view: 120°, operating voltage: DC 10-36V

**47348 381,-**

**Replacement camera for wireless reversing system 47348**

**473481 196,-**

E8



- Wireless, encrypted 2.4 GHz transmission
- Ideal for cars, RVs and trailers
- Viewing angle (110°), distance reference lines to obstacle
- Monitor connection via 12 V cigarette lighter cable
- Camera for mounting on the number plate

When the colour monitor is switched on, the picture taken by the camera is sent to the monitor via a wireless signal. Built-in night vision technology also allows transmission of images in the dark.

**Technical data:** Operating temperature: – 10 °C to + 50 °C, transmission range: max. 10 m

**Monitor:** Screen diagonal: 3.5"/8.9 cm, resolution: 320 x 240, dimensions: ca. 100 x 75 x 22 mm, technology: LCD colour display, power supply: 12 V fuse: 1A,

**Camera:** Resolution: 640 x 480, night vision: 7 infrared LEDs, viewing angle: 110°, colour sensor: 1/4" colour CMOS, exposure correction / white balance: Automatic, camera tilt angle: Variable up to 30°, power supply: 12 V, IP class: IP65

**Transmitter:** Transmission: 2.4 GHz, range: max. 10 m, power supply via cigarette lighter cable.

**Scope of delivery:** Monitor, monitor mount, transmitter, camera and mounting material

**47349**

**141,-**

E24



**NEW**

## Digital link for wireless transmission of video signals

The wireless system transmits the reverse camera image to a monitor. Since there are no cables, installation is fast and easy. Operates with 12 V or 24 V system. Wireless range is also suitable for larger RVs and caravans.

Digital 2.4 GHz wireless transmission.

Scope of delivery: 1 receiver, 1 transmitter, incl. adapter for Carbest reversing systems.

**47439**

**142,-**



# Water pressure pumps and submersible pumps



## 3-chamber water pressure pump – 7 l/min, 1.4 bar

Self-priming. Connection via 1/2" outer threads incl. filter and hose adapter. Approx. size: L203 x W130 x H123 mm, 12 V, 3.0 A (max. 6.0 A).

**62055 87,20**

## 3-chamber water pressure pump – 10 l/min, 2.8 bar

Self-priming. Connection via 1/2" outer threads incl. filter and hose adapter. Approx. size: L203 x W130 x H123 mm, 12 V, 3.5 A (max. 7.5 A).

**62056 98,10**



## Submersible pumps

- Pipe connection for hoses with Ø 10 – 12 mm
- Can be connected with a hose clamp to any hose with a suitable diameter
- Suitable for short dry running
- Small diameter – suitable for small jerrycan openings

Not compliant for drinking water

No.	Designation	l/m	bar	Watt	Ø pump	Art. no.	Price
①	Submersible pump 10 l	10	1.5	50	38 mm	<b>62130</b>	<b>26,20</b>
②	Submersible pump 15 l	15	1.5	50	49 mm	<b>62131</b>	<b>14,-</b>
③	Submersible pump 20 l	20	1.5	80	52 mm	<b>62132</b>	<b>15,20</b>

# Powerful 12 V stainless steel exhaust hood



Stainless steel housing, with lights 2x1.5 W LED (2x80 lumens), warm white (3,000 Kelvin), suction power 98 m³/h, 12 V, only for RVs and caravans.

Dimensions W 40 x D 27 x H 5 cm. Weight 1.8 kg

**31852 141,-**



# Powerful 230 V generators with integrated charge connection

- 230 V at any time, additional 12 V charge current 5/8 A
- Overload indicator, low oil indicator, power indicator
- Load-dependent rotational speed for low fuel consumption
- Converter technology: clean sinus curve, also for sensitive consumers

These generators are light, compact and user-friendly. They provide an independent 230 V power source for your devices or for charging batteries. Converter technology ensure optimal sinus curve. This also allows connection of sensitive devices. The generators have an economy function to reduce the motor speed. This reduces the fuel consumption significantly based on the power requirements of the connected devices. All generators are equipped with a low oil indicator and an earth connection.

Technical data	CI 1000	CI 2000	CI 3000
Max. power (230 V)	1000 W	2600 W	3300 W
Max. continuous power (230 V)	900 W	2300 W	3100 W
12 V charge output	12 V/5 A	12 V/8.3 A	12 V/8.3 A
Sockets 230 V/12 V	1xSchuko / 1x12 V	2xSchuko / 1x12 V	2xSchuko / 1x12 V
Motor / starter	4-cycle OHV / cable		
Tank capacity	2.7l	4.5l	4.5l
Operating time (full load)	4.1 h/tank filling	3.6 h/tank filling	3/tank filling
Sound pressure at 7 m	58 dB/7m	58 dB/7m	58 dB/7m
Dimensions (LxWxH) m	490x275x415	660x376x590	660x376x591
Weight/ protection type	ca. 15 kg/IP 23	ca. 30 kg/IP 23	ca. 30 kg/IP 35
Article number	92603	926010	926020
Price	382,-	687,-	829,-



## Tambour door complete set

- For construction of an upward opening tambour door
- For maximum door size 100 cm high 60 cm wide
- Allows opening even if space is limited
- Includes cut-to-fit roller slats, track and fascia trim

The running tracks, roller slats and the fascia trim can be cut to the desired door size and cabinet depth.  
Material: Gray plastic.

### Tambour door set consisting of:

- 1 x roller slats with recessed handle, H 100xB 60 cm
- 4 x screw-on running tracks, L 100 cm
- 4 x 90° screw-on guide sections
- 1 x fascia trim, L 100 cm

53044

87,20

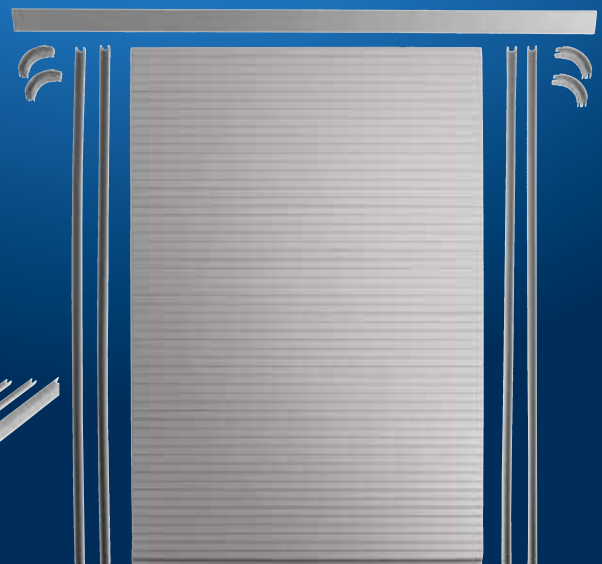
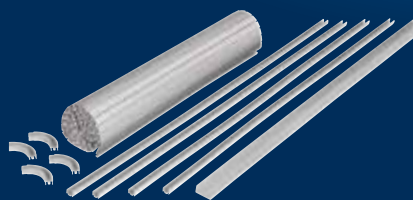

NEW

# Power Vent rooflights with or without 12 V fan



- UV resistant
- Integrated insect protection
- Opens and closes manually
- For roofs with thickness of 25–80 mm

## Power Vent without 12 V fan

Cut-out size: 280 x 280 mm  
 Total size: 365 x 365 mm  
 Hood: Crystal (opal glass appearance)  
 Weight: ca. 2.1 kg

**318530 63,20**

## Power Vent with 12 V fan

Cut-out size: 280 x 280 mm  
 Total size: 365 x 365 mm  
 Technical data for fan:  
 Power: 9.6 W, capacity 9 m<sup>3</sup>/h  
 Noise level ≤ 50dB, Ø 175 mm,  
 5 fan blades, weight: ca. 2.3 kg  
 Hood: white (opaque)

**31853 87,10**

# High-quality rooflights

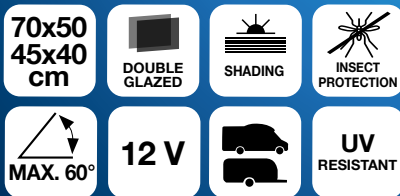

- In 2 sizes: 70 x 50 or 45 x 40 cm
- Double glazed and UV-resistant
- Integrated shading system
- Integrated insect protection
- Built-in LEDs and switch
- Maximum opening to 60°
- Pneumatic springs for easy operation
- For roofs with thickness of 25–60 mm



## Panorama rooflight, 70 x 50 cm

Cut-out size: 702 x 502 mm  
 Total size: 833 x 633 mm  
 Hood: tinted acrylic glass  
 Weight: ca. 8.0 kg

### Without forced ventilation

**31854 490,-**

### With forced ventilation

**318540 490,-**

## Rooflight 45 x 40 cm

Cut-out size: 452 x 402 mm  
 Total size: 577 x 577 mm  
 Hood: tinted acrylic glass  
 Weight: ca. 5.5 kg

### Without forced ventilation

**31851 382,-**

### With forced ventilation

**318510 382,-**



Integrated insect protection and shading system in the interior frame.



4 integrated LED lights in the interior with ON/OFF switch.



# Terrific views

with the frame vent windows, including a shading system and insect protection

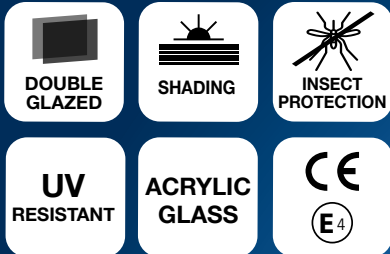

- Integrated shading system
- Integrated insect protection
- Manual telescopic opening
- Double glazed
- UV-resistant
- For walls with thickness up to 30 mm ± 1.5 mm

**NEW**



**Size:**  
**500 x 350 mm**

---

Cut-out size:  
502 x 352 mm

Total size:  
529 x 379 mm

Weight: ca. 4.0 kg  
**318580    250,-**

**Size:**  
**500 x 450 mm**

---

Cut-out size:  
502 x 452 mm

Total size:  
529 x 479 mm

Weight: ca. 4.2 kg  
**31858    262,-**

**Size:**  
**700 x 400 mm**

---

Cut-out size:  
702 x 402 mm

Total size:  
729 x 429 mm

Weight: ca. 5.5 kg  
**31859    316,-**

**Size:**  
**900 x 450 mm**

---

Cut-out size:  
902 x 452 mm

Total size:  
929 x 479 mm

Weight: ca. 7.0 kg  
**31857    371,-**

**Size:**  
**1100 x 450 mm**

---

Cut-out size:  
1102 x 452 mm

Total size:  
1129 x 479 mm

Weight: ca. 8.5 kg  
**31855    415,-**

# Escali – The multi-function ladder with a max. length of 3.2 m

- Ideal for loading the roof box or for cleaning the caravan or RV
- 11-step, extended height max. 3.2 m!
- Folds together for compact storage in boot or rear garage
- Max. load capacity 150 kg, weight ca. 9.1 kg
- Working height ca. 4.2 m

Safety information: The Escali multi-function ladder must extend 70 cm over the contact edge in accordance with TÜV regulations!

## Escali multi-function ladder

Approved in acc. with EN 131-6.

Packed size: H ca. 77 cm, W ca. 44/46 cm

440130 141,-

## Escali multi-function ladder

EN 131 approved. Packed size: H ca. 95 cm, W ca. 47 cm

44013 109,-



# Compact aluminium folding ladder with max. length of 2.1 m

- Material: Lightweight aluminium
- Load capacity up to max. 150 kg

## Aluminium folding ladder

With 6 steps. Dimensions opened: 210x45x6 cm, dimensions closed: 210x6x6 cm.

Weight: ca. 3.8 kg

44005

74,10



# Self-adhesive premium furniture design foil

for custom decoration of smooth indoor furniture surfaces.



- Can be repositioned repeatedly without residue
- Can be attached and removed several times
- Air-channel technology for bubble-free surface
- Whiteboard function for foil type White high gloss (51925)\*
- \*We recommend using only special whiteboard markers for writing
- High temperature fastness (-20 °C to +80 °C)
- Tangible surface structures (dependent on design)
- Foil size: W x L 62 x 230 cm

 NOCE RINALDI 51928 30,60	 LAKE CONSTANCE BEECH 51921 30,60	 ACACIA CURTIS 51920 30,60	 SCANDIC PINE 51923 30,60	 ANDERSON PINE 51924 30,60
 FLAT BLACK 51927 30,60	 SAND METALLIC 51922 30,60	 ALUMINIUM 51926 30,60	 SINGAPORE 51919 30,60	 WHITE HIGH GLOSS 51925 30,60

## Easy to install:



### Mounting set

For uncomplicated application of the design foil. Consists of plastic squeegee and cutter knife.

51930 12.99

Foil GP 21,46/1 sq.m



# Practical travel accessories



## Air compressor

Premium metal compressor for tyres, swimming aids and inflatable boats. Mini compressor, 12 volt, 360 watt, pressure 10 bar/150 PSI, 72 litres per minute pump volume. Integrated thermal protection switch and robust metal housing. Transport bag and valve bonnets included. With battery terminals for direct connection to the battery.

47408 109,-



Stand-up **Reserved** sign.  
For RVs and caravans.

Dimensions: 61.5 x 30 cm

47085 13,10



## Tyre protection, set of 2

reduces deformation of tyres during extended parked time. Suitable for wheels from 10" to 20".  
Dimensions: 44 x 20 x 4 cm

91528 14,20

# Folding caravan steps



## ① Steel caravan step

Load capacity up to 130 kg.  
Size opened: 62 x 40 x 23 cm.  
Size closed: 48 x 30 x 8 cm.  
Weight: ca. 3.2 kg.

91184 30,60



## ② Aluminium caravan step

Load capacity up to 150 kg.  
Size opened: 60 x 48 x 22 cm.  
Size closed: 48 x 37 x 7.5 cm.  
Weight: ca. 3.1 kg.

91190 64,30

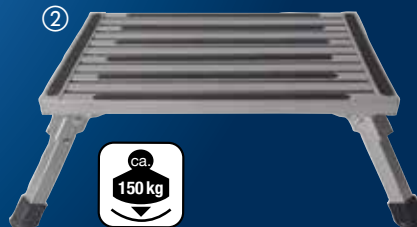

## ③ Folding caravan step

very practical with high load capacity. With large step surface of 37 x 31 cm and non-slip surface. Height: 24 cm. Folded together it is only 5 cm high and therefore easy to stow. Load capacity up to 130 kg. Packed size 38 x 37 x 5 cm. Polypropylene. Weight ca. 2.1 kg.

91185 18,50



## ④ Plastic caravan step

folding. Load capacity up to 150 kg.  
Size: 420 x 280 x 260 mm.

91194 20,70



# Practical travel accessories



**NEW**

**Tested in 10,000 km endurance test**

## Universal navigation system and mobile phone holder

With suction cup mounting, 360° rotating, retaining clips open to 105 mm wide. Material: ABS+PU, colour black, dimensions: 12x10x7.5 cm. (Smart phone not included).

46238 6,55



**Simultaneously charge a smart phone and tablet**

## 2-way USB distributor

USB charging plug with 2x2.4 A, also suitable for charging tablets

813031 10,90



## Steel wheel claw –

### Anti-theft guard for cars and trailers

Steel wheel claw for wheels with width up to 26.5 cm. 2 keys included. Dimensions: ca. 23x50 cm, weight: ca. 2.3 kg.

913401 41,50



**NEW**

## Battery-operated camping light with insect killer

With 3.7 V, 2000 mAh Li-Polymer battery. Charge via micro-USB. For use on a table or for hanging by integrated hook. Material: ABS, dimensions: 88x129 mm, weight: ca. 205 g

83494 27,30

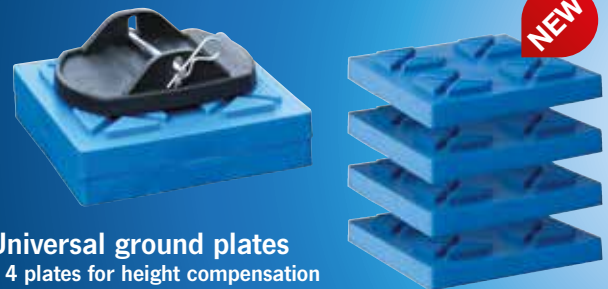

**NEW**

## Universal ground plates

- 4 plates for height compensation
- Clip-in anchor model

For height compensation under camper jacks and support feet. Dimensions: 21x21x3.3 cm, weight per plate 310 g

4 items 91187 16,40



**4er SET**

## Aluminium camper jack set, 4-piece

- Height adjustable from 28.5 – 42 cm
- 1000 kg load capacity each
- With metal spindle, stackable

Width: ca. 16 cm, height: 23 cm. Weight 3.2 kg

912061 45,80



**NEW**

## Support feet, set of 4

Set of 4 plastic support plates for steady legs with metal pin in yellow. Ideal for use in combination with caravan pads 911951.

91195 10,90

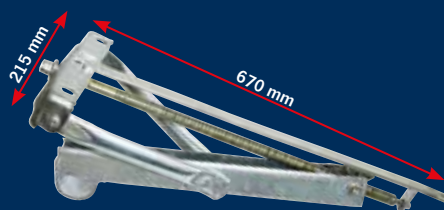

## Galvanized universal steady leg

- Static load capacity: 600 kg per leg
- Extended length: 497 mm

Weight: 3.5 kg 912323 39,30



**NEW**

## Caravan pads, set of 4

Stackable. Base for support feet, perfect height compensation 40 – 150 mm. Ideal for non-level terrain. Perfect for use with support feet 91195.

911951 13,10

# Protect your valuables



①



③

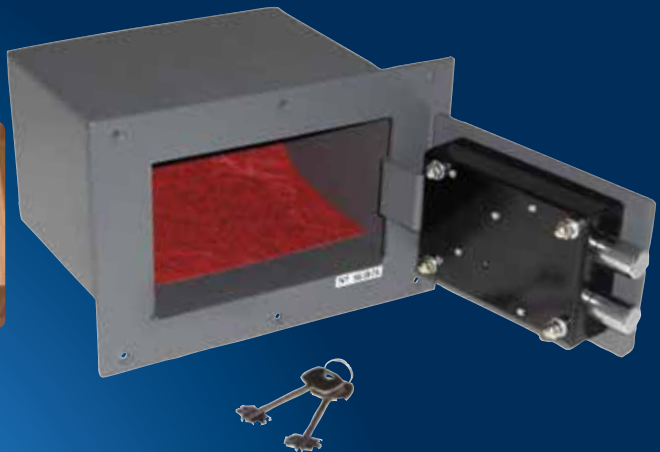

②



④

⑤



## ① Key safe

Versatile key safe of robust metal and steel braces. For storing keys, for example. With individually configurable 4-digit code.

Outer dimensions: D50xW75xH190 mm. Weight: 700 g.

47151

27,30

## ② Safety – portable safe box

Safety includes a bolt-on mount that allows easy insertion and removal. The safe box is firmly connected to the mount by means of a latch plate.

Dimensions: Mount ca. B16xT22xH7 cm, cartridge ca. W15xD21.5xH6 cm. Weight: 1.7 kg. Scope of delivery: Safe box, mount, 2 keys, 6 bolts.

47132

26,20

## ③ Jan – smaller built-in safe for vans

Small but very sturdy safe. (Opening W155xH105 mm). Massive lock and solid double bolt. Designed for concealed installation.

Dimensions: ca. W240xH170xD180 mm, installed dimensions: ca. W200xH130xD180 mm. Weight: ca. 4.0 kg.

Scope of delivery: Safe, 2 keys, 6 mounting bolts.

471362

50,10

## ④ Spike – wall / floor safe

Can be inconspicuously installed in furniture or a wall

Outer dimensions: ca. W39xD26xH18 cm,

housing dimensions: ca. W34xD21xH17.2 cm. Weight: 9.6 kg.

Scope of delivery: Safe, 2 keys, fastening material

471361

54,40

## ⑤ Rex – versatile furniture safe

Whether it is installed in a cabinet or bookshelf, in a caravan, RV, yacht or office, Rex will keep your belongings safely under lock and key. Weight: 6.8 kg. Outer dimensions: ca. W31xD20xH20 cm,

scope of delivery: Safe, 2 keys, fastening material

47136

54,40

# Reliable gas detectors and smoke detectors for RVs & caravans

## GasCube – 3 in 1 gas detector in exquisite design

- Warns of leaking propane/butane gas (LPG), carbon monoxide and so-called KO gases
- Optical and acoustic signal of operational readiness, calibration phase and alarm
- Blue light = ready / Red light = alarm!

### ① GasCube gas detector

Permanent connection to 12 V on-board power supply. Push-button switch. Ready for operation after about 3 minutes. With high-sensitivity sensor and loud 80 dB siren. Temperature-controlled sensor functions reliably also above 25 °C. Power consumption in standby: 100 mA, power consumption in case of alarm: 180 mA. Installation: ca. 100 cm above the ground. Dimensions: 55.6x86.7x24 mm.

Colour: White high gloss **80248** **68,60**

### ② NEW! GasCubePlus with additional external gas sensor

Features identical to GasCube above, but with external gas sensor. The additional sensor detects the gas concentration in the air just as effectively as the main sensor for additional safety in the case of rising and falling gases. The main sensor should be installed about 100 cm above the ground, the smaller external sensor about 30 cm above the ground (cable length: ca. 2.70 m). Allows detection of virtually every type of gas.

Colour: Anthracite high gloss **80249** **120,-**

③ Counter display with 10x GasCube 80248 **802481** **686,-**

### ④ LPG gas detector at a SUPER price

Warns reliably in case of gas leaks, acoustic alarm 85 dB, installation height for butane / propane gas detection ca. 20 to 40 cm above the ground. 12 volts, power consumption 100 mA. Temperature range – 10/+ 50 °C. Dimensions 115x70x60 mm. Scope of delivery: LPG gas detector, mounting material **80216** **37,-**

### ⑤ 2 in 1 combination gas detector

- Warns of LPG, CO 150PPM and other narcotic gases
- 2 integrated sensors
- Self-test function, acoustic and optical alarm
- Suitable for wall mounting

Operating voltage: DC 12 volt  
 Temperature range: 0 °C ~ +50 °C  
 Alarm signal tone: 85 dB/3 m  
 LPG gas alarm: Continuous tone  
 Dimensions: 118.5x82x43 mm **80218** **51,30**

### ⑥ Battery-operated smoke detector

- Detection area 20 m<sup>2</sup>
- 9 V block battery including function test

With test button and function test. Alarm as tone and light signal, loudness >85 dB/3 m, sensitivity 2.06%/ft. Monitoring area: 20 sq.m. Dimensions Ø128x38 mm. Standard DIN EN14604,UL217. Battery life ca. 1 year. **80299** **14,20**



Narcotic gas is lighter than air. The sensors should therefore be installed somewhat above sleeping height; butane / propane gas and carbon monoxide are heavier than air, these sensors should therefore be installed somewhat below sleeping height. (Before the gas can reach you.) In combined systems, sensors should be installed at sleeping height.



