



ALLES FÜR REISEMOBILE,  
CAMPING & CARAVANS

# Instruction - Aufbauanleitung

## Storage 2

937720

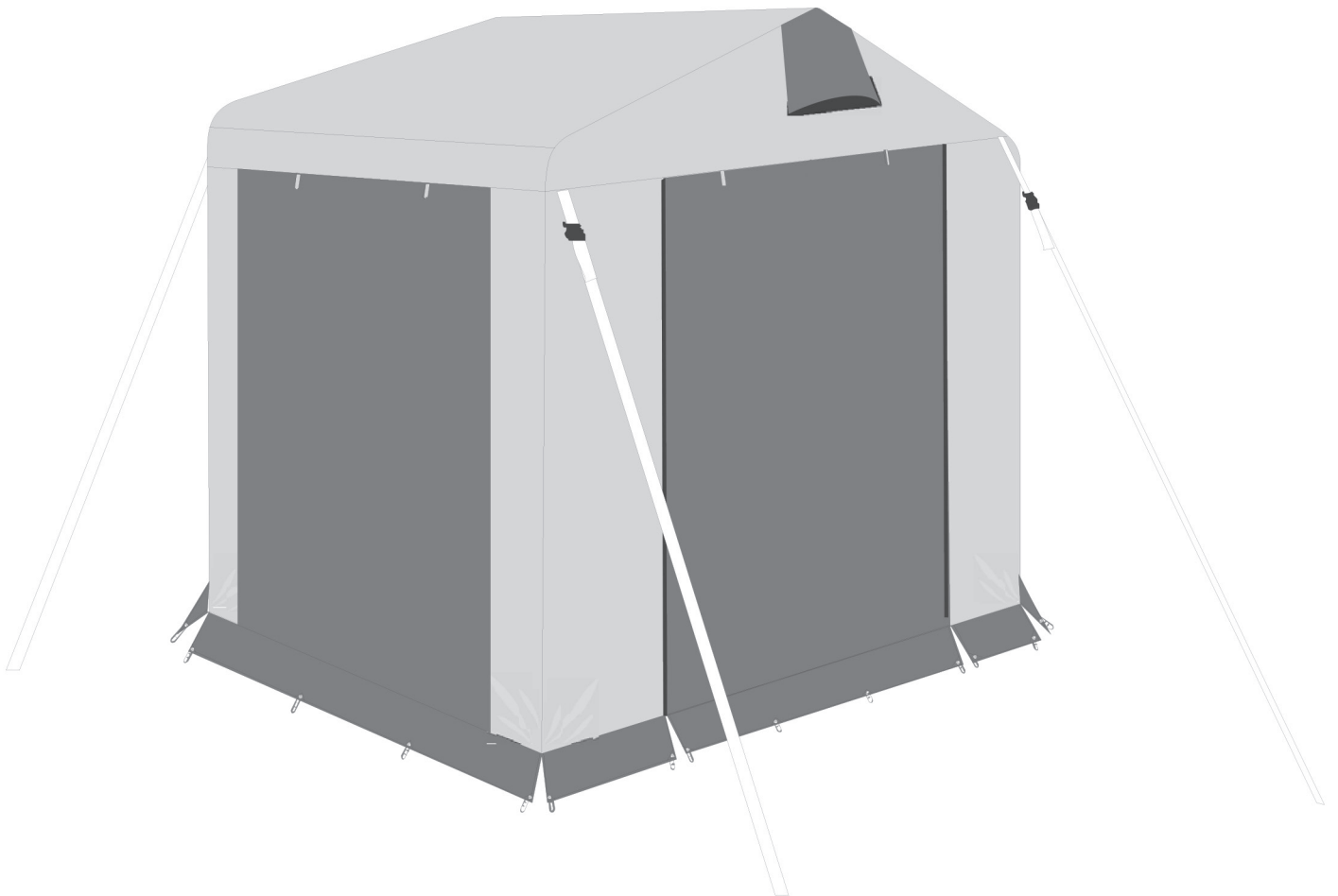

# Assembly Parts List - Lieferumfang

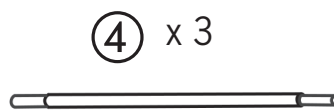
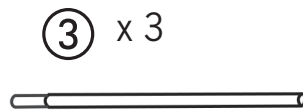
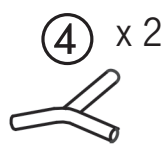
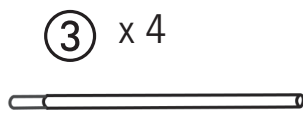
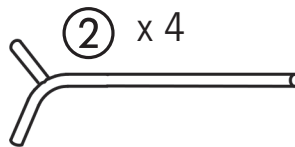
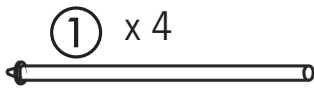
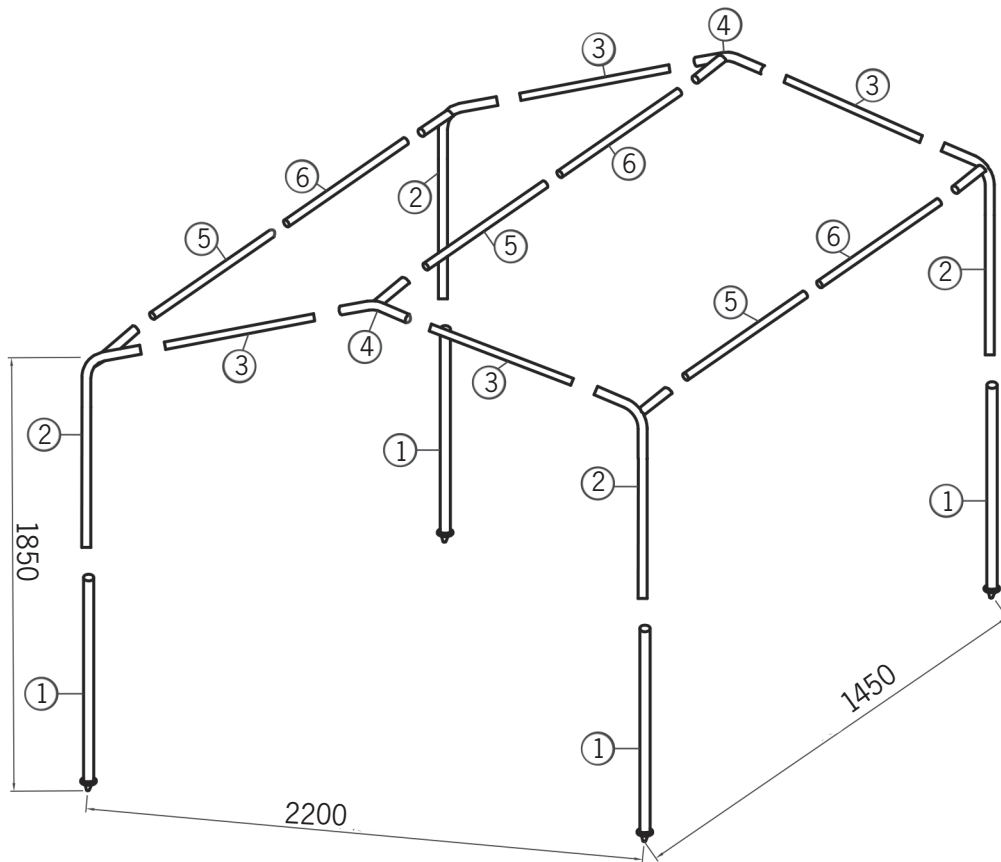

Cover  
Zelthaut  
x 1

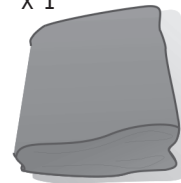

Pegging ladder  
Abspannleitern  
x 19



Metal pegs  
Metallheringe  
x 17



Storm Strap  
Sturmsicherung  
x 4



Plastic pegs  
Plastikheringe  
x 23



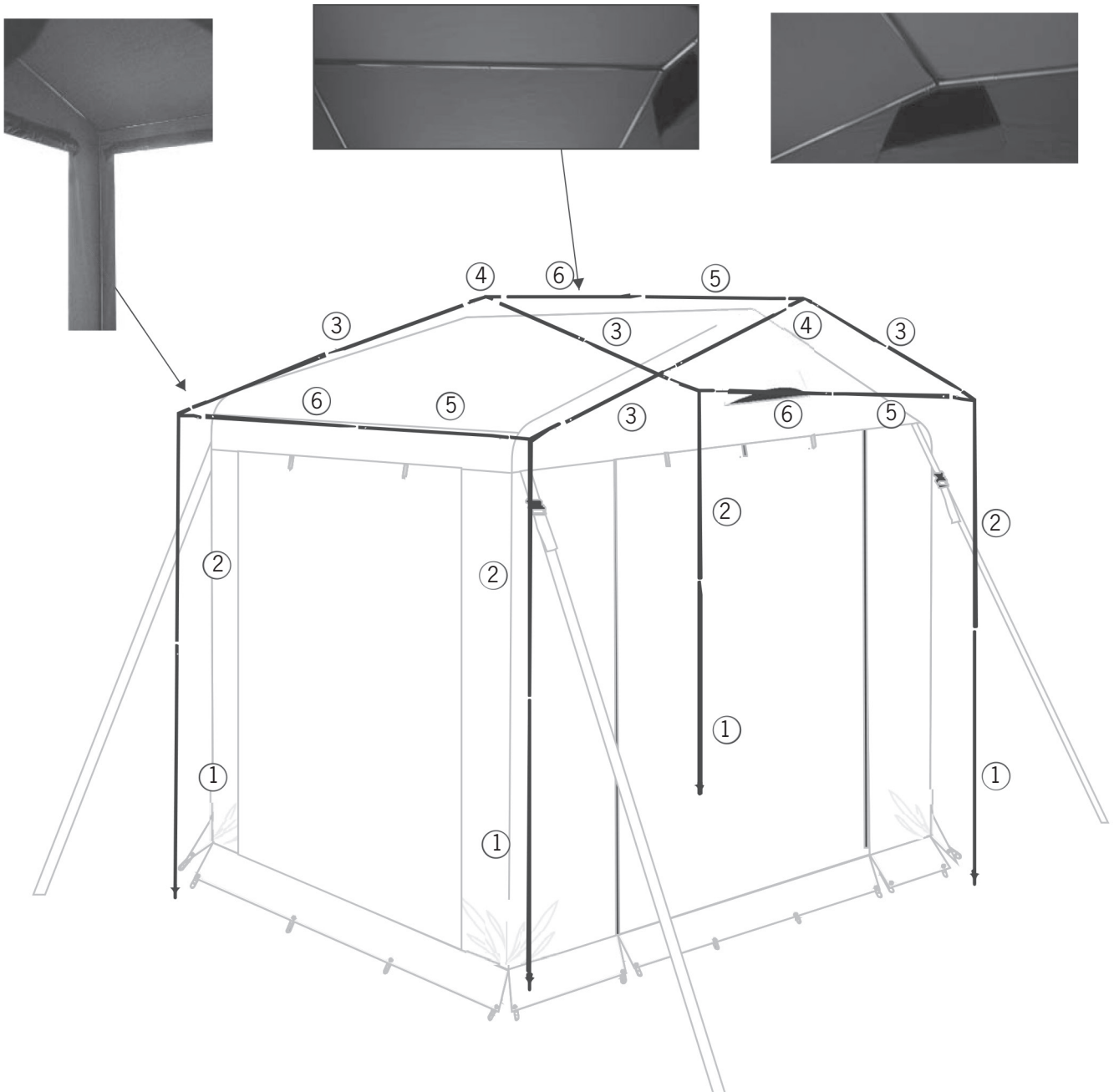

1. a) Assemble the poles like the above drawing, except the leg pole 1  
 b) Put the cover over the frame, and ensure that it is the correct way around  
 c) Raise the legs by connectin pole 1
- a) Montieren Sie die Stangen außer Stange 1 wie auf der obigen Zeichnung angegeben  
 b) Ziehen Sie die Zelthaut ordnungsgemäß über den Rahmen  
 c) Montieren Sie die Stange 1 in die Stange 2

2. a) Strengthen the tent by storm straps at four corner  
b) Peg the tent at the bottom

- a) Sichern Sie das Zelt mit den Sturmsicherungen  
b) Befestigen Sie das Zelt am Boden

